

LED



LED-S11-A60

LED-S11-A60 AC220-240V, 9W, E-27, 3000K

LED-S11-A60 AC220-240V, 9W, E-27, 4000K

- Lumen +/-10% (lm): 810
- CAP: E27
- Length: 111mm
- Diameter: 60mm
- Equivalent: 60W
- CRI (RA): >80
- Beam angle: 280
- Warranty: 2 years
- Body material: PC+AL
- Cover material: PC



LED-S11-A60

LED-S11

LED-S11 AC220-240V, 15W, E-27, 3000K - A65

LED-S11 AC220-240V, 15W, E-27, 4000K - A70

- Lumen +/-10% (lm): 1350
- CAP: E27
- Length: 128mm
- Diameter: 65mm
- Equivalent: 91W
- CRI (RA): >80
- Beam angle: 280
- Warranty: 2 years
- Body material: PC+AL
- Cover material: PC



LED-S11

LED A60

LED A60 AC220-240V, 6W, E-27, 470lm, 3000K

LED A60 AC220-240V, 6W, E-27, 470lm, 4000K

LED A60 AC220-240V, 12W, E-27, 1055lm, 3000K

LED A60 AC220-240V, 12W, E-27, 1055lm, 4000K

LED A60 AC220-240V, 9W, E-27, 810lm, 3000K **dimmable**

LED A60 AC220-240V, 9W, E-27, 810lm, 4000K **dimmable**



LED A60



LED G45 E27

LED G45 E27

LED G45 AC220-240V, 3W, E-27, 250lm, 3000K

LED G45 AC220-240V, 3W, E-27, 250lm, 4000K

LED G45 AC220-240V, 6W, E-27, 470lm, 3000K

LED G45 AC220-240V, 6W, E-27, 470lm, 4000K

LED G45 E14

LED G45	AC220-240V, 3W, E-14, 250lm, 3000K
LED G45	AC220-240V, 3W, E-14, 250lm, 4000K
LED G45	AC220-240V, 5W, E-14, 400lm, 3000K
LED G45	AC220-240V, 5W, E-14, 400lm, 4000K



LED G45 E14

LED G95

LED G95	AC220-240V, 15W, E-27, 1055lm, 3000K
LED G95	AC220-240V, 15 W, E-27, 1055lm, 4000K



LED G95

LED G120

LED G120	AC220-240V, 18W, E-27, 1550lm, 3000K
LED G120	AC220-240V, 18W, E-27, 1550lm, 4000K



LED G120

LED-S11-C37 LED C37

LED-A11-C37	AC220-240V, 5W, E-14, 400lm, 3000K
LED-A11-C37	AC220-240V, 5W, E-14, 400lm, 4000K
LED C37	AC220-240V, 3W, E-14, 250lm, 3000K
LED C37	AC220-240V, 3W, E-14, 250lm, 4000K



LED-S11-C37 / LED C37

LED GU10 COB

LED GU10 DIMMABLE

LED GU10 COB AC220-240V, 5W, GU10, 38° 400lm, 3000K

LED GU10 COB AC220-240V, 5W, GU10, 38° 400lm, 4000K

LED GU10 COB AC220-240V, 7W, GU10, 38° 560lm, 3000K

LED GU10 COB AC220-240V, 7W, GU10, 38° 560lm, 4000K

LED GU10 DIMMABLE AC220-240V, 5W, GU10, 38° 400lm, 3000K

LED GU10 DIMMABLE AC220-240V, 5W, GU10, 38° 400lm, 4000K

LED GU10 DIMMABLE AC220-240V, 5W, GU10, 38° 400lm, 6000K



LED GU10 COB / LED GU10 DIMMABLE



1LED-S11 5.5W GU10 DIMMABLE

1LED-S11 5.5W GU 10 DIMMABLE AC220-240V, 5.5W, GU10, 38°, 6500K



1LED-S11 5.5 GU10 DIMMABLE



LED MR16 COB

LED MR16 COB

LED MR16COB AC/DC12V, 5W, GU5.3, 38°, 400LM, 3000K

LED MR16COB AC/DC12V, 5W, GU5.3, 38°, 400LM, 4000K

LED-S11 GU10 5W

LED-S11 GU10 5W 220-240V, 5W, 120°, 3000K

LED-S11 GU10 5W 220-240V, 5W, 120°, 4000K

LED-S11 GU10 5W 220-240V, 5W, 120°, 6500K

- Lumen +/-10% (lm): 400
- CAP: E27
- Length: 57mm
- Diameter: 50mm
- Equivalent: 35W
- CRI (RA): >80
- Beam angle: 120
- Warranty: 2 years
- Body material: PC+AL
- Cover material: PC



LED-S11 GU10 5W

LED GU10, GU10 SMD DIMMABLE

LED GU10 8W 120°, 8W, 600lm, 3000K

LED GU10 8W 120°, 8W, 600lm, 4000K

GU10 SMD DIMMABLE 220-240V, 5W, 3000K, 400lm, 100°

LED GU10 7W 220-240V, 7W, 3000K, 560lm, 100°

LED GU10 7W 220-240V, 7W, 4000K, 560lm, 100°



LED GU10 / GU10 SMD

NYB 3x1W WARM WHITE 3000K



NYB 3x1W WARM WHITE 3000K POWER LED 230V, GU10, 3x1W, 45°, 240lm

- **Dimension:** Ø50x57mm

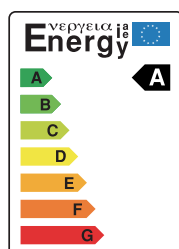

NYB 3x1W WARM WHITE 3000K



NYB GU10

NYB GU10 230V, 1x3W WW, 2700-3000K, GU10, 40°

- **Dimension:** Ø50x57mm



NYB GU10



LED GU10

LED GU10 1x3W WW, 220-240V, GU10, 3000K, LEĆA 30°



LED GU10



3.5W GU10 CAMETA

GU10 CAMETA NW 220-240V AC, 24°, ~4000K

GU10 CAMETA NW 220-240V AC, 24°, ~6500K

- Closed to the standard size, compatible with more fixture
- Cameta design: anti glare, highly simulate the traditional lighting effect
- Sharp LED, the color temperature is more stable
- High efficacy up to 60lm/W in 3000K



3.5W GU10 CAMETA





LED PAR16



LED PAR16

LED PAR16 LR0407-35H35D 220-240V, 7W, GU10, 4000K, 35°

LED PAR16 LR1107s-35H35D 220-240V, 7W, GU10, 4000K, 35°

- Lamp Life: 25000 hrs
- Max. Luminous intensity (cd): 600
- Operating temp.: -30 to +40 °C
- Diameter: 50mm
- Lenght: (LR0407-35h35D)74mm
- Lenght: (LR0407s-35h35D)79mm
- Weight: 83g

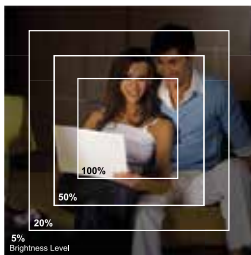

LED PAR16



LED PAR16

LED PAR16 LR0705-WFL 220-240V, 5W, GU10, 4000K, 40°

LED PAR16 LR0707-SP 220-240V, 7W, GU10, 4000K, 15°

- Lamp Life: 20000 hrs
- Max. Lum. int. (cd) LR0705-WFL: 328
- Max. Lum. int. (cd) LR0707-SP: 1600
- Operating temp.: -30 to +40 °C
- Diameter: 50mm
- Lenght: 74mm
- Weight (LR0707-SP): 82g
- Weight (LR0707-SP): 83g



SL-SMD-AR111-GU10

SL-SMD-AR111-GU10 DIMMABLE

SL-SMD-AR111-GU10 12W AL. 12LED AC, 85-265V, 45°, 950lm, 3000K

SL-SMD-AR111-GU10 12W AL. 12LED AC, 85-265V, 45°, 950lm, 4000K

SL-SMD-AR111-GU10 12W AL. 12LED AC, 85-265V, 45°, 950lm, 6000K

SL-SMD-AR111-GU10 12W AL. DIMMABLE 12LED AC, 230V, 45°, 900lm, 3000K

SL-SMD-AR111-GU10 12W AL. DIMMABLE 12LED AC, 230V, 45°, 900lm, 4000K

SL-SMD-AR111-GU10 12W AL. DIMMABLE 12LED AC, 230V, 45°, 900lm, 6000K

- Dimension: 110*110*75mm
- Material: Aluminium
- LED QTY: 12 Pcs
- Packing: Color box
- 12W
- 85-265V
- Ra: 80
- GU10



SL-SMD-AR111-GU10



AR111 COB 12V WHITE



AR111 COB 12V BLACK

AR111 COB 12V

LED G53 24°, G53, WHITE BODY, 2800K, 1050lm, 15W

LED G53 24°, G53, WHITE BODY, 4500K, 1050lm, 15W

LED G53 24°, G53, BLACK BODY, 2800K, 1050lm, 15W

LED G53 24°, G53, BLACK BODY, 4500K, 1050lm, 15W



LED LR0815-50H08D

LED LR0115S-50H24D



LED LR0815-50H08D
LED LR0115S-50H24D

LED LR0815-50H08D

GU10, 4000K, 220-240V, 50Hz

LED LR0115S-50H24D

GU10, 4000K, 4STEP, DIMMABLE 220-240V, 50Hz

- 15W
- Lamp Life: 30000h
- Max. Lum. Int. (LR0815-50h08D): 1600
- Max. Lum. Int. (LR0115S-50H24D): 3600
- Beam Angle: (LR0815-50h08D): 8°
- Beam Angle: (LR0115S-50H24D): 24°
- Length: (LR0815-50h08D): 94mm
- Length: (LR0115S-50H24D): 93
- Diameter: 111mm
- Weight: (LR0815-50h08D): 264mm
- Weight: (LR0115S-50H24D): 240mm

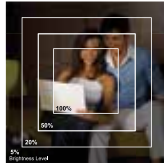

4-Step Dimming

100% 50% 20% 5%
Dims on Regular Switches

SL-PC-G4H

SL-PC-G4H 2W, AC/DC12V, 12PCS 2835, 2800-3000K

SL-PC-G4H 2W, AC/DC12V, 12PCS 2835, 4000K



SL-PC-4GH 2W

SL-PC-G9HD

SL-PC-G9HD 3W, 230V, DIMMABLE 14PCS 2835, 2800-3000K

SL-PC-G9HD 3W, 230V, DIMMABLE 14PCS 2835, 4000K

SL-PC-G9HD 5W, 230V, DIMMABLE 24PCS 2835, 2800-3000K

SL-PC-G9HD 5W, 230V, DIMMABLE 24PCS 2835, 4000K



SL-PC-G9HD



LED-S19-A60

LED-S19-A60 220-240V, 4W, E27, 3000K, 400lm



LED-S19-A60



RGBW MODUL/ŽARULJA

RGBW MODUL/ŽARULJA

RGBW MODUL/ŽARULJA Ø50mm, 12V

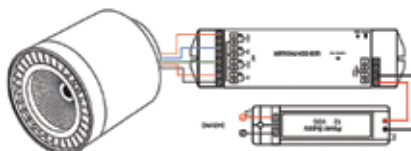

LED-AG-FLAL

LED-AG-FLAL 60W 220-240V, E27, 6500K, 5400lm

LED-AG-FLAL 100W 220-240V, E40, 6500K, 9000lm



LED-AG-FLAL

R7S

R7S 78mm*24mm SMD-PC 5W, 175-265V, 3000K

R7S 118mm*24mm SMD-PC 10W, 175-265V, 3000K



R7S 78mm



R7S 118mm

G125

G125	AMBER	220-240V, 6W, E27, 600lm, 2700K
G125	SMOKE	220-240V, 6W, E27, 300lm, 2700K
G125	AMBER DIMMABLE	220-240V, 6W, E27, 600lm, 2700K



G125 AMBER



G125 SMOKE



G125 AMBER DIMMABLE



G45 DIMMABLE

G45 DIMMABLE	CLEAR GLASS SHELL	E27, 220-240V, 4W, 2700K
G45 DIMMABLE	AMBER GLASS SHELL	E27, 220-240V, 4W, 2700K



G45 SHORT FILAMENT
AMBER GLASS SHELL



G45 SHORT FILAMENT
CL GLASS SHELL



ST64 AMBER



ST64 SMOKE



ST64 AMBER DIMMABLE

ST64

ST64 AMBER

ST64 SMOKE

ST64 AMBER DIMMABLE

220-240V, 6W, E27, 600lm, 2700K

C35 DIMMABLE

C35 DIMMABLE CLEAR GLASS SHELL 220-240V, 4W, E14, 2700K



C35 CLEAR GLASS SHELL

C35

C35 AMBER 220-240V, 4W, E14, 400lm, 2700K

C35 AMBER DIMMABLE 220-240V, 4W, E14, 400lm, 2700K



C35 AMBER



C35 AMBER DIMMABLE



ST30-300mm E27

ST30-300mm E27 220-240V, 8W, 2000-2200K, SHORT FILAMENT (AMBER GLASS SHELL)



ST30-300mm E27



T10-185mm DIMMABLE

T10-185mm DIMMABLE

T10-185mm DIMMABLE

E27, 220-240V, 3W, 2700K, AMBER GLASS SHELL

BT75

BT75 AMBER GLASS SHELL E27, 220-240V, 6W, 2700K

BT75 DIMMABLE AMBER GLASS SHELL E27, 220-240V, 6W, 2700K



B75 SHORT FILAMENT



B75 SHORT FILAMENT DIMMABLE

A60

A60 DIMMABLE AMBER GLASS SHELL E27, 220-240V, 6W, 2700K

A60 DIMMABLE CLEAR GLASS SHELL E27, 220-240V, 4W, 2700K

A60 CLEAR GLASS SHELL E27, 220-240V, 4W, 2700K

A60

A60 AMBER 220-240V, 6W, E27, 600lm, 2700K

A60 SMOKE 220-240V, 6W, E27, 300lm, 2700K



A60 AMBER GLASS SHELL DIMMABLE



A60 CLEAR GLASS SHELL DIMMABLE



A60 CLEAR GLASS SHELL



A60 AMBER



A60 SMOKE



RED

GREEN

BLUE

PURPLE

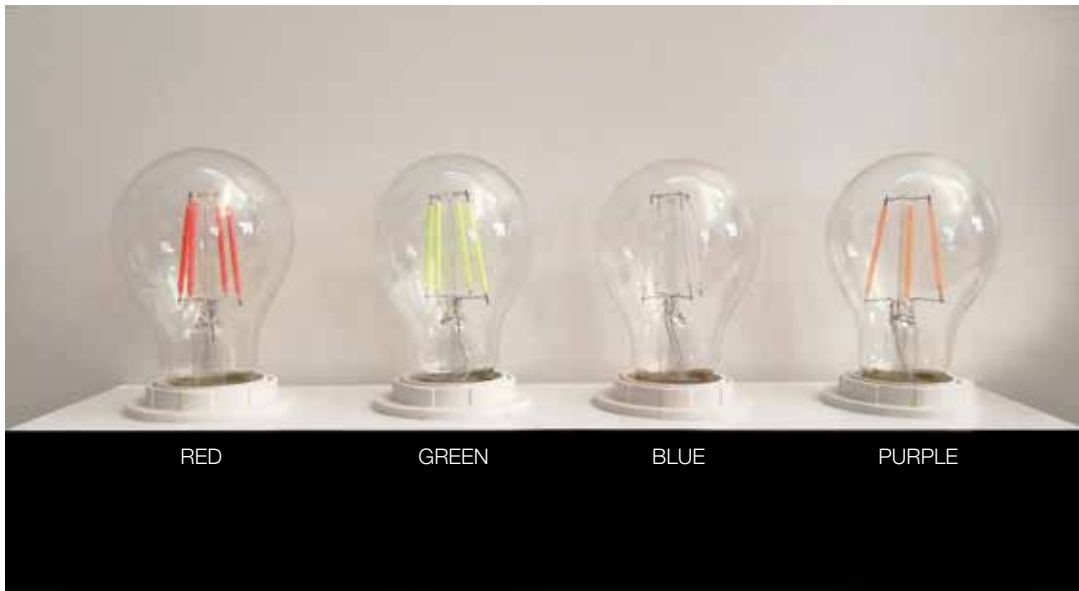

RED

GREEN

BLUE

PURPLE

A60 COLOR

A60 RED LED FILAMENT	CLEAR GLASS	E27, 220-240V, 4W
A60 BLUE LED FILAMENT	CLEAR GLASS	E27, 220-240V, 4W
A60 GREEN LED FILAMENT	CLEAR GLASS	E27, 220-240V, 4W
A60 RED PURPLE FILAMENT	CLEAR GLASS	E27, 220-240V, 4W



MAX-AL-4W-001 ELLIPSE



MAX-AL-4W-004 TUBULAR



MAX-AL-4W

MAX-AL-4W-001	ELLIPSE	Size: 60,5*162mm
MAX-AL-4W-004	TUBULAR	Size: 50*165mm
MAX-AL-4W-013	TUBULAR	Size: 30,5*196mm
MAX-AL-4W-008	ROUND	Size: 85*145mm
MAX-AL-4W-011	Y-SHAP	Size: 40*123mm

4W±10%, AC220-240V, 50 Hz, 55-65lm/W, Ra80, 2200K



MAX-AL-4W-013 TUBULAR



MAX-AL-4W-008 ROUND



MAX-AL-4W-011 Y-SHAP

LED-T8

LED T8 TUBE



Description	LED-T8 60CM 230V-9W-G13-4000K-900lm	LED-T8-GL 60CM 230V-9W-G13-6500K-900lm	LED-T8 120CM 230V-18W-G13-4000K-1800lm	LED-T8 120CM 230V-18W-G13-6500K-1800lm	LED-T8 150CM 230V-24W-G13-4000K-2400lm	LED-T8 150CM 230V-24W-G13-6500K-2400lm
Wattage (W)	9	9	18	18	23	23
Lumen Output (lm)	1260	1260	2520	2520	3220	3220
Lumen Efficacy (lm/W)	140	140	140	140	140	140
Dimension D*L (mm)	600*30*30	600*30*30	1200*30*30	1200*30*30	1500*30*30	1500*30*30
Color Temp.	4000K	6500K	4000K	6500K	4000K	6500K
IP	IP20	IP20	IP20	IP20	IP20	IP20
Beam angle	200°	200°	200°	200°	200°	200°
LED	SMD2835	SMD2835	SMD2835	SMD2835	SMD2835	SMD2835
Cap	G13	G13	G13	G13	G13	G13
Input	AC220-240V	AC220-240V	AC220-240V	AC220-240V	AC220-240V	AC220-240V
Hz	50Hz	50Hz	50Hz	50Hz	50Hz	50Hz
Ra	80	80	80	80	80	80
PF	0,9	0,9	0,9	0,9	0,9	0,9
Life Time	25000h	25000h	25000h	25000h	25000h	25000h
EEL	A+	A+	A+	A+	A+	A+
Individual packaging	color box	color box	color box	color box	color box	color box

T8 FIXTURE FOR LED T8 TUBE

LED T8 TUBE

Opis proizvoda	T8 Fixture 1*1200mm + LED T8 tube 1*18W	T8 Fixture 2*1200mm + LED T8 tube 2*18W	T8 Fixture 1*600mm for LED T8 tube 1*9W	T8 Fixture 1*1200mm for LED T8 tube 1*18W	T8 Fixture 1*1500mm for LED T8 tube 1*24W	T8 Fixture 2*600mm for LED T8 tube 2*9W	T8 Fixture 2*1200mm for LED T8 tube 2*18W	T8 Fixture 2*1500mm for LED T8 tube 2*24W
Snaga (W)	1x18	2x18	1x9	1x18	1x24	2x9	2x18	2x24
Dužina (mm)	1200	1200	600	1200	1500	600	1200	1500



LED MODUL BL-LMN5630W03

LED MODUL BL-LMN5630W03 SAMSUNG 5630 LED

40-50lm/LED, DC12V, Al. PCB, 6000-7000K

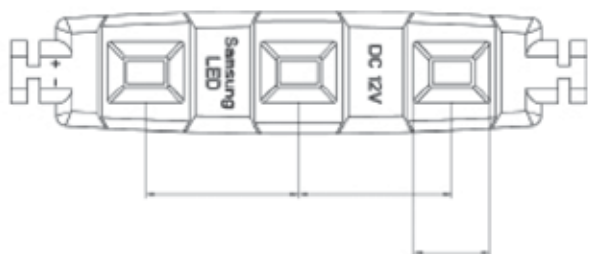

Waterproof Module 3-LED
with aluminum PCB

Description	5630 LED Module 3-LED
Power (W)	1.24
LED quantity	3
Dimensions (mm)	63.5X16X6.8
IP rating	65
Colour temperature (K)	6000
Lumens output (Lm)	105- 115
Luminous efficacy (Lm/W)	>88
Angle (°)	120
Type of LED	5630 SAMSUNG
PCB	Aluminum
Housing	PVC
Voltage (V)	12
Driver position	outside
Lifespan (hours)	50000
Light degradation	(%/xHours)
Materials	PVC casing + Aluminum PCB
Working Temperature (°C)	-40 - 85
Warranty	3 year

LED MODUL BL-LMN5050RGB03

LED MODUL BL-LMN5050RGB03 SAMSUNG 5630 LED

DC12V, RGB FULL COLOR

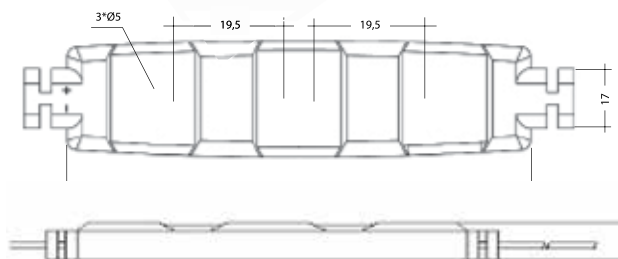

Waterproof Module 3-LED
with aluminum PCB

Description	EPISTAR 5050LED
Power (W)	0.72
LED quantity	3
Dimensions (mm)	65.5X17X6.5
IP rating	65
Colour temperature (K)	RGB tri-color
Lumens output (MCD)	R: 1200-1800 mcd G: 2700-3300 mcd B: 2700-3300 mcd
Luminous efficacy (Lm/W)	
Angle (°)	120
Type of LED	5060 SMD
PCB	FR4 PCB
Housing	PVC
Voltage (V)	12
Driver position	outside
Lifespan (hours)	> 30000
Light degradation (%/xHours)	
Materials	PVC casing + FR4 PCB
Working Temperature (°C)	-40 - 85
Warranty	2 year

WATERPROOF 3535 LED MODULE WITH LENS IN VIEWING ANGLE 20°*90°

WITH ALUMINIUM PCB + SCREW HOLE + ABS CASING + LENS + ALUMINIUM COOLING PART BACKSIDE

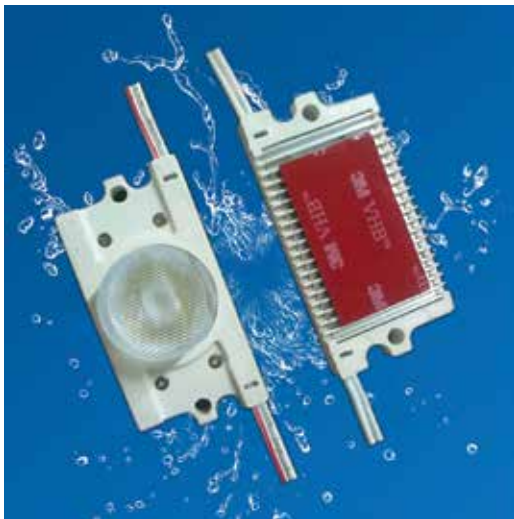

Description	Waterproof 3535 LED Module
Power (W)	2.7W
LED quantity	1
Dimensions (mm)	70x35x20.7
IP rating	67
Colour temperature (K)	6000-8000
Lumens output (Lm)	230-240
Luminous efficacy (Lm/W)	>85m/W
Angle (°)	20° * 70°
Type of LED	3535 SMD
PCB	Aluminum
Housing	ABS
Voltage (V)	12V DC
Driver position	outside
Lifespan (hours)	50000
Light degradation	(%/xHours)
Materials	ABS casing + Aluminum PCB + Aluminium cooling part
Ambient Temperature (°C)	-40 - 85
Warranty	5 years

Notes: every module can be cut

LED MODUL BL-LMN2835W04 SAMSUNG LED

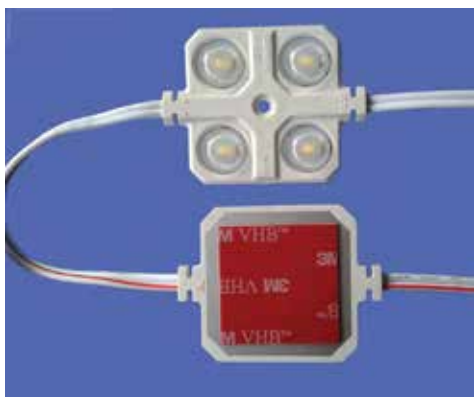

Description	5630 LED Module 4-LED
Power (W)	2,2
LED quantity	3
Dimensions (mm)	44x44x8
IP rating	65
Colour temperature (K)	3000-3500, 6000-12000
Lumens output (Lm)	105- 115
Luminous efficacy (Lm/W)	>88
Angle (°)	120
Type of LED	2835 SAMSUNG
PCB	Aluminum
Housing	PVC
Voltage (V)	12
Driver position	outside
Lifespan (hours)	50000
Light degradation	(%/xHours)
Materials	PVC casing + Aluminum PCB
Working Temperature (°C)	-40 - 85
Warranty	3 year

12VDC SINGLE COLOR 4,8W

LED TRAKA



NAZIV	SMD	LED/m	SNAGA (W)	VDC	IP ZAŠTITA	BOJA (K)
RED color Flexible led IP20 12VDC 4,8W/m	3528	60	4,8	12	20	RED
GREEN color Flexible led IP20 12VDC 4,8W/m	3528	60	4,8	12	20	GREEN
BLUE color Flexible led IP20 12VDC 4,8W/m	3528	60	4,8	12	20	BLUE
RED color Flexible led IP65 12VDC 4,8W/m	3528	60	4,8	12	65	RED
GREEN color Flexible led IP65 12VDC 4,8W/m	3528	60	4,8	12	65	GREEN
BLUE color Flexible led IP65 12VDC 4,8W/m	3528	60	4,8	12	65	BLUE

12VDC RGB+W

LED TRAKA

NAZIV	SMD	LED/m	SNAGA (W)	VDC	IP ZAŠTITA	BOJA (K)
ML-RGBW 12V 14,4W/m IP20	5050	60	14,4	12	20	RGBW-3000/4000/6000
ML-RGBW 12V 14,4W/m IP65	5050	60	14,4	12	65	RGBW-3000/4000/6000

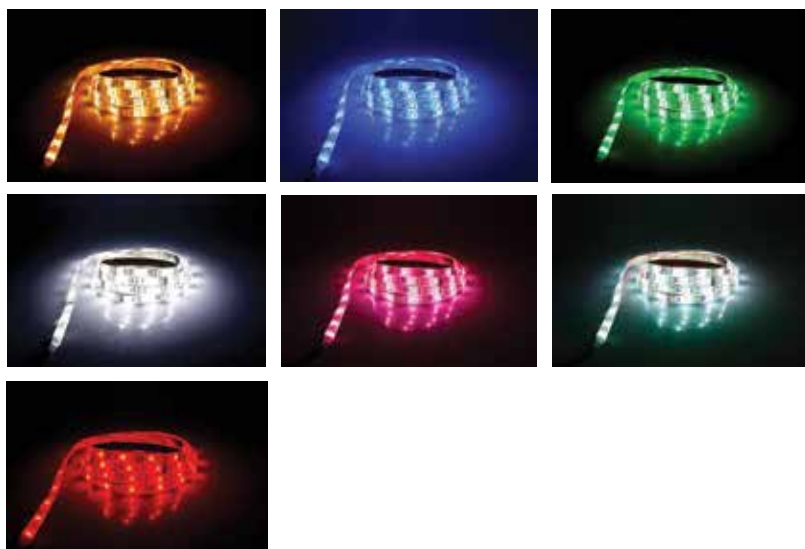



MSG-F2835-600-WT3

MSG-F2835-600-WT3 6000K LED TRAKA SMD 2835, 14,4W, 6000K, IP68, VDC 24, LED/m 120



MSG-FM5050-300-WT3 RGB

MSG-FM5050-300-WT3 RGB LED TRAKA SMD 5050, 14,4W, RGB, IP68, VDC 24, LED/m 60



IR-24/RWH-D060-35



IR-24/RWH-D060-35 WARM WHITE 5x8mm	3528 LED FLEXIBLE STRIP	4,8W, 2600-2900K, IP20, VDC 24, LED/m 60, GARANCIJA 3g
IR-24/RWH-D060-35 NEUTRAL WHITE 5x8mm	3528 LED FLEXIBLE STRIP	4,8W, 3700-4300K, IP20, VDC 24, LED/m 60, GARANCIJA 3g
IR-24/RWH-D060-35 WHITE 5x8mm	3528 LED FLEXIBLE STRIP	4,8W, 5700-6500K, IP20, VDC 24, LED/m 60, GARANCIJA 3g
IR-24/RWH-D060-35 NEUTRAL WHITE 5x10mm	3528 LED FLEXIBLE STRIP	4,8W, 3700-4300K, IP20, VDC 24, LED/m 60, GARANCIJA 3g
IR-24/RWH-D060-35 WHITE 5x10mm	3528 LED FLEXIBLE STRIP	4,8W, 5700-6500K, IP20, VDC 24, LED/m 60, GARANCIJA 3g



IR-24/RWH-B120-35



IR-24/RWH-B120-35 WHITE 5x8mm	3528 LED FLEXIBLE STRIP	9,6W, 5700-6500K, IP20, VDC 24, LED/m 120, GARANCIJA 3g
IR-24/RWH-B120-35 WARM WHITE 5x10mm	3528 LED FLEXIBLE STRIP	9,6W, 2600-2900K, IP65, VDC 24, LED/m 120, GARANCIJA 3g
IR-24/RWH-B120-35 WHITE 5x10mm	3528 LED FLEXIBLE STRIP	9,6W, 5700-6500K, IP65, VDC 24, LED/m 120, GARANCIJA 3g

DJ60-12V-8mm

DJ60WW812-IP20	SMD2835, 60LEDs/m, 12V/DC, 4.8W, 3000K
DJ60NW812-IP20	SMD2835, 60LEDs/m, 12V/DC, 4.8W, 4000K
DJ60W812-IP20	SMD2835, 60LEDs/m, 12V/DC, 4.8W, 6000K
DJ60WW812-IP55	SMD2835, 60LEDs/m, 12V/DC, 4.8W, 3000K
DJ60NW812-IP55	SMD2835, 60LEDs/m, 12V/DC, 4.8W, 4000K
DJ60W812-IP55	SMD2835, 60LEDs/m, 12V/DC, 4.8W, 6000K

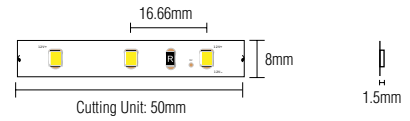

DJ860-12V-10mm

D860WW812-IP20	SMD2835, 60LEDs/m, 12V/DC, 7.2W, 3000K
D860NW812-IP20	SMD2835, 60LEDs/m, 12V/DC, 7.2W, 4000K
D860W812-IP20	SMD2835, 60LEDs/m, 12V/DC, 7.2W, 6000K
D860WW812-IP55	SMD2835, 60LEDs/m, 12V/DC, 7.2W, 3000K
D860NW812-IP55	SMD2835, 60LEDs/m, 12V/DC, 7.2W, 4000K
D860W812-IP55	SMD2835, 60LEDs/m, 12V/DC, 7.2W, 6000K

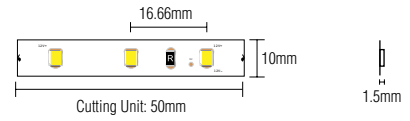

DJ120-12V-8mm

DJ120WW812-IP20	SMD2835, 120LEDs/m, 12V/DC, 9.6W, 3000K
DJ120NW812-IP20	SMD2835, 120LEDs/m, 12V/DC, 9.6W, 4000K
DJ120W812-IP20	SMD2835, 120LEDs/m, 12V/DC, 9.6W, 6000K
DJ120WW812-IP55	SMD2835, 120LEDs/m, 12V/DC, 9.6W, 3000K
DJ120NW812-IP55	SMD2835, 120LEDs/m, 12V/DC, 9.6W, 4000K
DJ120W812-IP55	SMD2835, 120LEDs/m, 12V/DC, 9.6W, 6000K

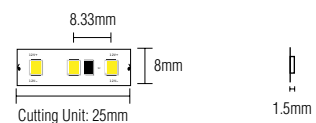

D8120-12V-8mm

D8120WW812A-IP20	SMD2835, 120LEDs/m, 12V/DC, 14.4W, 3000K
D8120NW812A-IP20	SMD2835, 120LEDs/m, 12V/DC, 14.4W, 4000K
D8120W812A-IP20	SMD2835, 120LEDs/m, 12V/DC, 14.4W, 6000K
D8120WW812A-IP55	SMD2835, 120LEDs/m, 12V/DC, 14.4W, 3000K
D8120NW812A-IP55	SMD2835, 120LEDs/m, 12V/DC, 14.4W, 4000K
D8120W812A-IP55	SMD2835, 120LEDs/m, 12V/DC, 14.4W, 6000K

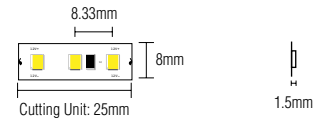

D872-12V-6mm

D8721206NO-8WW-IP20-BENDABLE	SMD2835, 72LEDs/m, 12V/DC, 5.8W, 3000K
D8721206NO-8NW-IP20-BENDABLE	SMD2835, 72LEDs/m, 12V/DC, 5.8W, 4000K

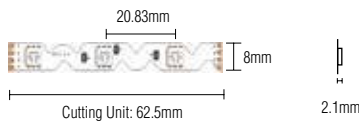
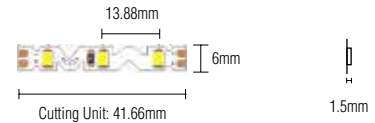

D548RGB-12V-8mm

D5481208NO-RGB-IP20-BENDABLE	SMD2835, 48LEDs/m, 12V/DC, 8W, RGB
-------------------------------------	------------------------------------

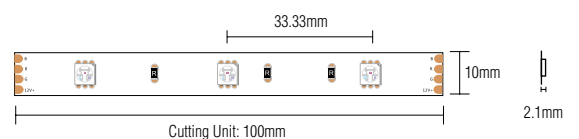

D530RGB-12V-10mm

D530RGB-12-10-IP20	SMD2835, 30LEDs/m, 12V/DC, 7.2W, RGB
D530RGB-12-10-IP55	SMD2835, 30LEDs/m, 12V/DC, 7.2W, RGB



D560RGB-12V-10mm

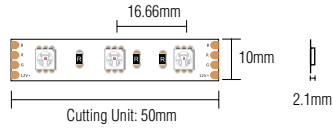

D560RGB-12-10-IP20

SMD2835, 60LEDs/m, 12V/DC, 14,4W, RGB

D560RGB-12-10-IP55

SMD2835, 60LEDs/m, 12V/DC, 14,4W, RGB

DJ60-24V-8mm

DJ60WW824-IP20

SMD2835, 60LEDs/m, 24V/DC, 4.8W, 3000K

DJ60NW824-IP20

SMD2835, 60LEDs/m, 24V/DC, 4.8W, 4000K

DJ60W824-IP20

SMD2835, 60LEDs/m, 24V/DC, 4.8W, 6000K

DJ60WW824-IP55

SMD2835, 60LEDs/m, 24V/DC, 4.8W, 3000K

DJ60NW824-IP55

SMD2835, 60LEDs/m, 24V/DC, 4.8W, 4000K

DJ60W824-IP55

SMD2835, 60LEDs/m, 24V/DC, 4.8W, 6000K

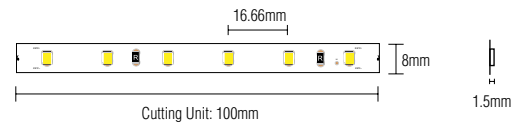

D860-24V-8mm

D860WW824-IP20

SMD2835, 60LEDs/m, 24V/DC, 7.2W, 3000K

D860NW824-IP20

SMD2835, 60LEDs/m, 24V/DC, 7.2W, 4000K

D860W824-IP20

SMD2835, 60LEDs/m, 24V/DC, 7.2W, 6000K

D860WW824-IP55

SMD2835, 60LEDs/m, 24V/DC, 7.2W, 3000K

D860NW824-IP55

SMD2835, 60LEDs/m, 24V/DC, 7.2W, 4000K

D860W824-IP55

SMD2835, 60LEDs/m, 24V/DC, 7.2W, 6000K

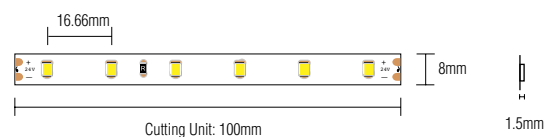

DJ120-24V-8mm

DJ120WW824-IP20	SMD2835, 120LEDs/m, 24V/DC, 9.6W, 3000K
DJ120NW824-IP20	SMD2835, 120LEDs/m, 24V/DC, 9.6W, 4000K
DJ120W824-IP20	SMD2835, 120LEDs/m, 24V/DC, 9.6W, 6000K
DJ120WW824-IP55	SMD2835, 120LEDs/m, 24V/DC, 9.6W, 3000K
DJ120NW824-IP55	SMD2835, 120LEDs/m, 24V/DC, 9.6W, 4000K
DJ120W824-IP55	SMD2835, 120LEDs/m, 24V/DC, 9.6W, 6000K

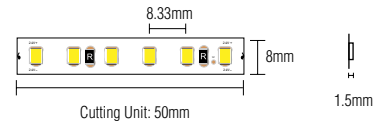

D8120-24V-8mm

D8120WW824A-IP20	SMD2835, 120LEDs/m, 24V/DC, 14.4W, 3000K
D8120NW824A-IP20	SMD2835, 120LEDs/m, 24V/DC, 14.4W, 4000K
D8120W824A-IP20	SMD2835, 120LEDs/m, 24V/DC, 14.4W, 6000K
D8120WW824A-IP55	SMD2835, 120LEDs/m, 24V/DC, 14.4W, 3000K
D8120NW824A-IP55	SMD2835, 120LEDs/m, 24V/DC, 14.4W, 4000K
D8120W824A-IP55	SMD2835, 120LEDs/m, 24V/DC, 14.4W, 6000K

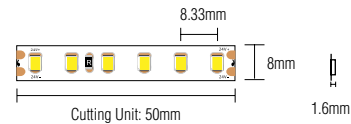

D530RGB-24V-8mm

D530RGB-24-10-IP20	SMD2835, 30LEDs/m, 24V/DC, 7.2W, RGB
D530RGB-24-10-IP55	SMD2835, 30LEDs/m, 24V/DC, 7.2W, RGB

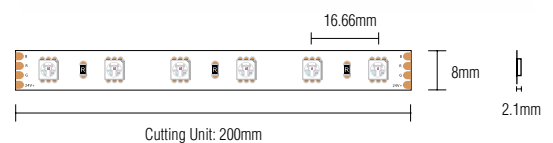

D560RGB-24V-10mm

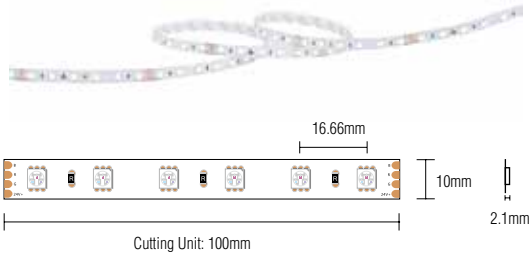

D560RGB-24-10-IP20 SMD2835, 60LEDs/m, 24V/DC, 14.4W, RGB

D560RGB-24-10-IP55 SMD2835, 60LEDs/m, 24V/DC, 14.4W, RGB

DJ240-24V-10mm

DJ2402410NO-8WWCDA12WC0500-IP20 SMD2835, 240LEDs/m, 24V/DC, 19.2W, 3000K

DJ2402410NO-8NWCDA12WC0500-IP20 SMD2835, 240LEDs/m, 24V/DC, 19.2W, 4000K

DJ2402410NO-8WCDA12WC0500-IP20 SMD2835, 240LEDs/m, 24V/DC, 19.2W, 6000K

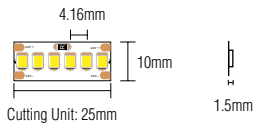

DF8-24V-8mm DF8ET-24V-8mm

DF8-24W-8WW-IP20 COF LED, 24V/DC, 11.2W, 2700K

DF8-24W-8NW-IP20 COF LED, 24V/DC, 11.2W, 4000K

DF8ET-24W-8WW-IP65 COF LED, 24V/DC, 11.2W, 2700K

DF8ET-24W-8NW-IP65 COF LED, 24V/DC, 11.2W, 4000K

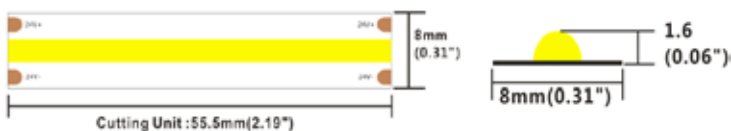

LED STRIP KONEKTOR

STRIP TO STRIP



LED STRIP KONEKTOR

STRIP TO WIRE



NAZIV ARTIKLA	OPIS	BOJA LED TRAKE	VRSTA SPOJA	ŠIRINA LED TRAKE	TRAKA IP
OL11-SEN8XB-2	LED strip connector	single color	strip to wire	8mm (4,8W; 9,6W)	IP20
OL11-SEN8BB-2	LED strip connector	single color	strip to strip	8mm (4,8W; 9,6W)	IP20
OL11-DJN8XB-2	LED strip connector	single color	strip to wire	8mm (4,8W; 9,6W)	IP20
OL11-DJN8BB-2	LED strip connector	single color	strip to strip	8mm (4,8W; 9,6W)	IP20
OL11-SEN10XB-2	LED strip connector	single color	strip to wire	10mm (7,2W; 14,4W)	IP20
OL11-SEN10BB-2	LED strip connector	single color	strip to strip	10mm (7,2W; 14,4W)	IP20
OL11-SEN10XB-4	LED strip connector	RGB	strip to wire	10mm (7,2W; 14,4W)	IP20
OL11-SEN10BB-4	LED strip connector	RGB	strip to strip	10mm (7,2W; 14,4W)	IP20
OL11-DJN10XB-2	LED strip connector	single color	strip to wire	10mm (4,8W; 7,2; 9,6; 14,4W)	IP54/IP65
OL11-DJN10BB-2	LED strip connector	single color	strip to strip	10mm (4,8W; 7,2; 9,6; 14,4W)	IP54/IP65
OL11-DJN10XB-4	LED strip connector	RGB	strip to wire	10mm (7,2W; 14,4W)	IP54/IP65
OL11-DJN10BB-4	LED strip connector	RGB	strip to strip	10mm (7,2W; 14,4W)	IP54/IP65

Step 1: Connect to LED Strip Light



1-1: Cut LED Strip along the cuttable mark

1-2: Remove protective paper of adhesive tape.

1-3: Insert LED strip to strip holder and press cap down

1-4: Finish connection to LED Strip

Step 2: Attach Wire to Connector

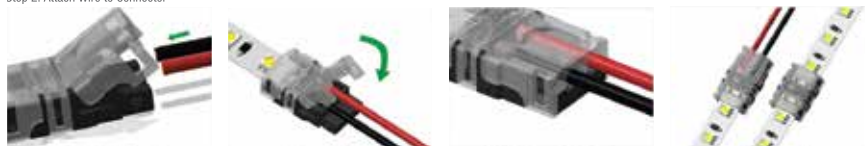

2-1: Insert wire to wire holder of connector

2-2: Down close cap of connector

2-3: Ensure cap is locked by base of connector

2-4: Connection completed

KONEKTOR IP65 SINGLE COLOR



KONEKTOR RGB IP65



KONEKTOR IP68 SINGLE COLOR



KONEKTOR RGB IP20



KONEKTOR RGBW IP20 4PIN



KONEKTOR IP20 SINGLE COLOR



VODOOTPORNNA NAPA JANJA 12V

JAH-12015A-V12	120x30x20mm	IP67, 12V, 15W
JAH-12030A-V12	200x30x20mm	IP67, 12V, 30W
JAH-12045A-V12	220x40x23mm	IP67, 12V, 45W
JAH-12060A-V12	150x70x45mm	IP67, 12V, 60W
JAH-12100A-V12	210x70x45mm	IP67, 12V, 100W
JAH-12150A-V12	220x70x45mm	IP67, 12V, 150W
JAH-12200C-V12	210x125x53mm	IP67, 12V, 200W



VODOOTPORNNA NAPA JANJA 24V

JAH-12030A-V24	200x30x20mm	IP67, 24V, 30W
JAH-12060A-V24	150x70x45mm	IP67, 24V, 60W
JAH-12100A-V24	210x70x45mm	IP67, 24V, 100W
JAH-12150C-V24	200x70x45mm	IP67, 24V, 150W



FCS-15-12V



AC INPUT VOLTAGE RANGE	170-250V
MAX. OUTPUT POWER	15W
OUTPUT VOLTAGE	12V±0.5V
MAX. OUTPUT ELECTRICAL CURRENT	0-1A
EFFICIENCY	≥80%
PFC	≥0.86
DIMENSION	Ø50X20mm

NAPAJANJA 12V

JAH-A-015-12	70,5x40x30mm	IP20, 12V, 15W
JAH-A-025-12	85x58x38mm	IP20, 12V, 25W
JAH-A-040-12	110x78x37mm	IP20, 12V, 40W
JAH-A-060-12	110x78x35mm	IP20, 12V, 60W
JAH-A-100-12	160x98x42mm	IP20, 12V, 100W
JAH-A-150-12	199x98x42mm	IP20, 12V, 150W
JAH-A-200-12	200x110x50mm	IP20, 12V, 200W
JAH-A-250-12	200x110x50mm	IP20, 12V, 250W
JAH-A-360-12	215x115x52mm	IP20, 12V, 360W
JAH-A-400-12	215x115x50mm	IP20, 12V, 400W
JAH-A-500-12	240x125x65mm	IP20, 12V, 500W



NAPAJANJA 24V

JAH-A-025-24	70,5x40x30mm	IP20, 24V, 25W
JAH-A-040-24	85x58x38mm	IP20, 24V, 40W
JAH-A-060-24	110x78x37mm	IP20, 24V, 60W
JAH-A-100-24	110x78x35mm	IP20, 24V, 100W
JAH-A-150-24	160x98x42mm	IP20, 24V, 150W
JAH-A-250-24	199x98x42mm	IP20, 24V, 250W
JAH-A-360-24	200x110x50mm	IP20, 24V, 360W

MW NAPA JANJA 12V/24V IP20



LRS-25	78x51x28mm	IP20, 12V, 25W	LRS-25	78x51x28mm	IP20, 24V, 25W
LRS-35	99x82x36mm	IP20, 12V, 35W	LRS-35	99x82x36mm	IP20, 24V, 35W
LRS-50	99x97x36mm	IP20, 12V, 50W	LRS-50	99x97x36mm	IP20, 24V, 50W
LRS-75	129x97x38mm	IP20, 12V, 75W	LRS-75	129x97x38mm	IP20, 24V, 75W
LRS-100	159x97x38mm	IP20, 12V, 100W	LRS-100	159x97x38mm	IP20, 24V, 100W
LRS-150	199x98x42mm	IP20, 12V, 150W	LRS-150	199x98x42mm	IP20, 24V, 150W
RSP-200	215x115x30mm	IP20, 12V, 200W	RSP-200	215x115x30mm	IP20, 24V, 200W



MW NAPA JANJA 12V/24V IP20



RSP-320	215x115x60mm	IP20, 12V, 320W
RSP-320	215x115x60mm	IP20, 24V, 320W



ERPF NAPA JANJA 12V/24V IP20



ERPF 400	200x130x45mm	IP20, 12V, 400W
ERPF 400	200x130x45mm	IP20, 24V, 400W



MW VODOOTPORNA NAPAJANJA 12V/24V IP67



LPV-20	118x35x26mm	IP67, 12V, 20W	LPV-20	118x35x26mm	IP67, 24V, 25W
LPV-35	148x40x30mm	IP67, 12V, 35W	LPV-35	148x40x30mm	IP67, 24V, 35W
LPV-60	162,5x42,5x32mm	IP67, 12V, 60W	LPV-60	162,5x42,5x32mm	IP67, 24V, 60W
LPV-100	190x52x37mm	IP67, 12V, 100W	LPV-100	190x52x37mm	IP67, 24V, 100W
LPV-150	191x63x37,5mm	IP67, 12V, 150W	LPV-150	191x63x37,5mm	IP67, 24V, 150W



YSL12-1200280D

DIMMABLE DRIVER ZA SD PANELE 3W



YSL36-5300280D

DIMMABLE DRIVER ZA SD PANELE 9-16W



YSL40-9000280D

DIMMABLE DRIVER ZA SD PANELE 18-24W



YSL80-4500950D

DIMMABLE DRIVER ZA P1 PANELE 40W



JAH-UT60-12

JAH-UT60-12 ULTRA SLIM LONG CASE SUPPLY 175x52x22mm DC12V5A



JAH-UT100-12

JAH-UT100-12 ULTRA SLIM LONG CASE SUPPLY 195x52x22mm DC12V8.3A



JAH-UT150-12

JAH-UT150-12 ULTRA SLIM LONG CASE SUPPLY 251x52x22mm DC12V12.5A



JAH-UT200-12

JAH-UT200-12 ULTRA SLIM LONG CASE SUPPLY 370x52x22mm DC12V16.5A



YSL30T-1202500

Constant Voltage Input: 230VAC 50Hz, Output:12V 30W max. DC 2.5A, Input and Output: Terminal Block, Short Circuit, over current, over voltage protection

- **Dimension:** 251*30*16mm



YSL30T-1202500

YSL60T-1205000

Constant Voltage Input: 230VAC 50Hz, Output:12V 60W max. DC 5A, Input and Output: Terminal Block, Short Circuit, over current, over voltage protection

- **Dimension:** 320*30*19mm



YSL60T-1205000

YSL100T-1208300

Constant Voltage Input: 230VAC 50Hz, Output:12V 100W max. DC 8.3A, Input and Output: Terminal Block, Short Circuit, over current, over voltage protection

- **Dimension:** 320*30*19mm



YSL100T-1208300

RF MODEL N12 1x11A 5-24V

Functions	
Brightness Level	11 Levels
Gentle Fading	Yes
Power Off memory	Yes
Power & LED Connector	
Power Connector	Slot screw terminal, max 17AWG each slot, two positive and two negative in parallel.
LED Connector	
Dimension & Weight	
Dimension	Main unit: 87x24x15mm, Remote: 86.5x36x7.5mm
Net Weight	38g



RF MODEL RGBW N40-S 3x3,5A+6A 5-24V

Functions	
White Control	Independent, 10 Levels brightness
RGB Dynamic Mode	43 modes
Dynamic Speed Level	10 Levels
Static Color	30 colors
Color Brightness Level	5 Levels
Gentle Fading	Yes
Power Off memory	Yes
Power & LED Connector	
Power Connector	Slot screw terminal, max 17AWG each slot, two positive and two negative in parallel.
LED Connector	
Dimension & Weight	
Dimension	Main unit: 87x24x15mm, Remote: 86.5x36x7.5mm
Net Weight	39g



RF RGBW CONTROLLER (10 ZONES)

MODEL: LC-2806 WITH LC-1003 SERIES



RGBW RECEIVER

MODEL: LC-1003



RF WIRELESS LED REMOTE CONTROLLER

MODEL: LC-2819 WITH LC-1009Fxx



RF WIRELESS LED REMOTE CONTROLLER

MODEL: LC-2819S WITH LC-1009Fxx



RF WIRELESS LED REMOTE CONTROLLER

MODEL: LC-2819S-DIM WITH LC-1009Fxx



RF WIRELESS LED REMOTE CONTROLLER

MODEL: LC-2818 WITH LC-1009Fxx



RGB REMOTE & WIFI TRANSMITTER RECEIVER

MODEL: LC-1009FA, LC-1009EA, LC-1009FA3, LC-1009 CS



LC-2818WiTR

12-24VDC, RF SIGNAL



LC-2818WiND

12VDC, RF SIGNAL/DMX512



RECEPTOR LC-1009SAC-HP

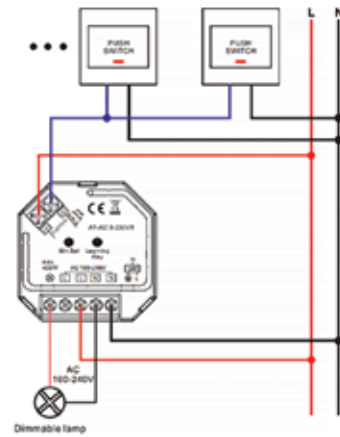

RF WIRELESS CCT DIMMER

MODEL: LC-2803B WITH LC 2501M



SINGLE ZONE RF WIRELESS LED DIMMER

MODEL: LC-2828 WITH LC-2501N SERIES



SINGLE ZONE RF WIRELESS CCT CONTROLLER

MODEL: LC-2828CCT WITH LC-2501M SERIES



MULTI ZONE RF WIRELESS DIMMER

MODEL: LC-2801 WITH 2501N



1 ZONES MINI RF SINGLE COLOR LED DIMMER



MODEL: LC-2807 WITH LC 2501N, NS



DIMMER RECEIVER

MODEL: LC-2501M, N, NS, C, RGB, LC-2502N



PANEL RF RGB DIMMER

MODEL: LC-2805DRGB



RF DIM PANEL DIMMER

MODEL: LC-2805D



RF WIRELESS WALL MOUNTED RGB/W CONTROLLER

MODEL: LC-2820 (BLACK&WHITE)



WALL MOUNTED RGB/W DMX512 CONTROLLER

MODEL: LC-2812



WALL MOUNTED RGB/W DMX512 CONTROLLER

MODEL: LC-2811DMX



DMX512 MASTER CDW WALL CONTROL PANEL

MODEL: LC-2201



RF OR DMX WALL MOUNTED TOUCH PANEL

MODEL: LC-2830-A-DC



RF OR DMX WALL MOUNTED TOUCH PANEL

MODEL: LC-2830B-DC



ONE ZONE DIM REMOTE

MODEL: LC-2833K1



TWO ZONE DIM REMOTE

MODEL: LC-2833K2



RF SINGLE COLOR WALL MOUNT/ STICK CONTROLLER

MODEL: LC-2835 DIM



RF RGB WALL STICKER/ MOUNT CONTROLLER

MODEL: LC-2835 RGB



RF 3000-6000K COLOR WALL MOUNT/STICK CONTROLLER

MODEL: LC-2835CCT



DMX512 DECODER (WITH SMART PUSH MASTER MODE)

MODEL: LC-2102BEA-RJ45/LC-2112B



DMX512 DECODER (WITH STAND-ALONE)

MODEL: LC-2103FA



RGBAW DMX512 DECODER

MODEL: LC-2104

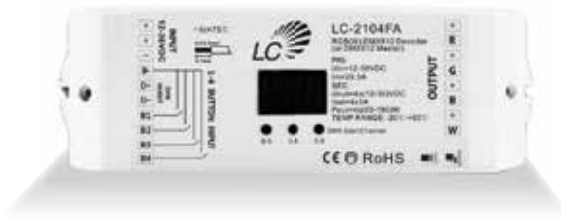

RGBAW DMX512 SWITCH DECODER

MODEL: LC-2703B



RF TO DMX



MODEL: LC-2815DMX1



DALI MASTER LC-2400TL

POGODAN ZA UPRAVLJANJE DIMABILNIM SVJETILJKAMA/ŽARULJAMA



Lamp 1:
Click to recall the first lamp.
Press and hold down to increase/
decrease light intensity Dimming
range from 0.1% to 100%

Lamp 2:
Click to recall the second lamp.
Press and hold down to increase/
decrease light intensity Dimming
range from 0.1% to 100%

Lamp 3:
Click to recall the third lamp.
Press and hold down to increase/
decrease light intensity Dimming
range from 0.1% to 100%

Lamp 4:
Click to recall the fourth lamp.
Press and hold down to increase/
decrease light intensity Dimming
range from 0.1% to 100%

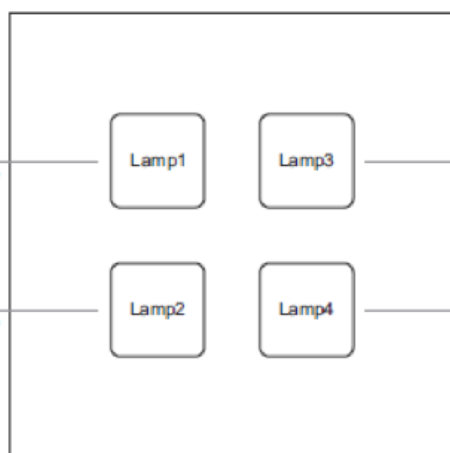

Front side

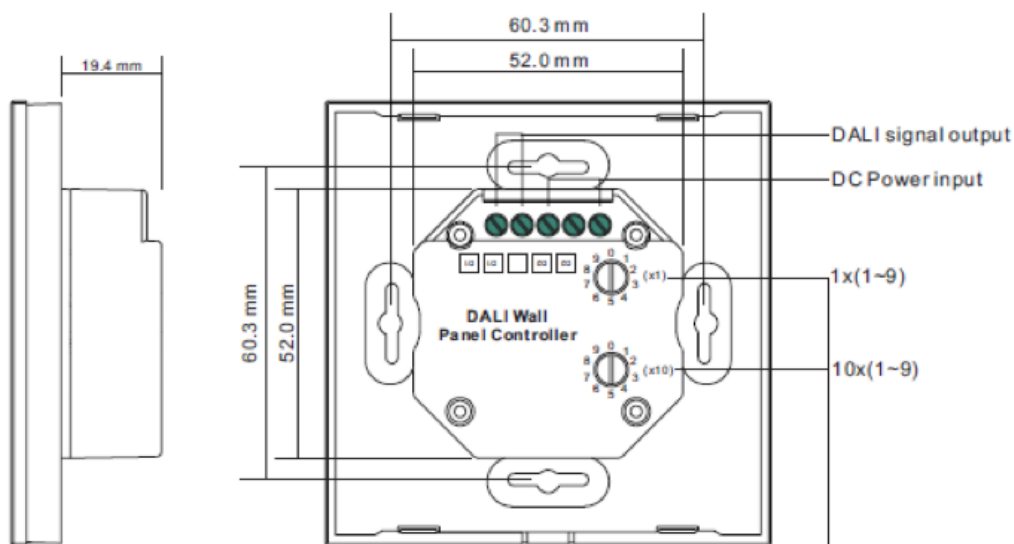

Set the The starting DALI address Number

DALI MASTER LC-2300TS DIM



POGODAN ZA UPRAVLJANJE JEDNOBOJNIM LED TRAKAMA

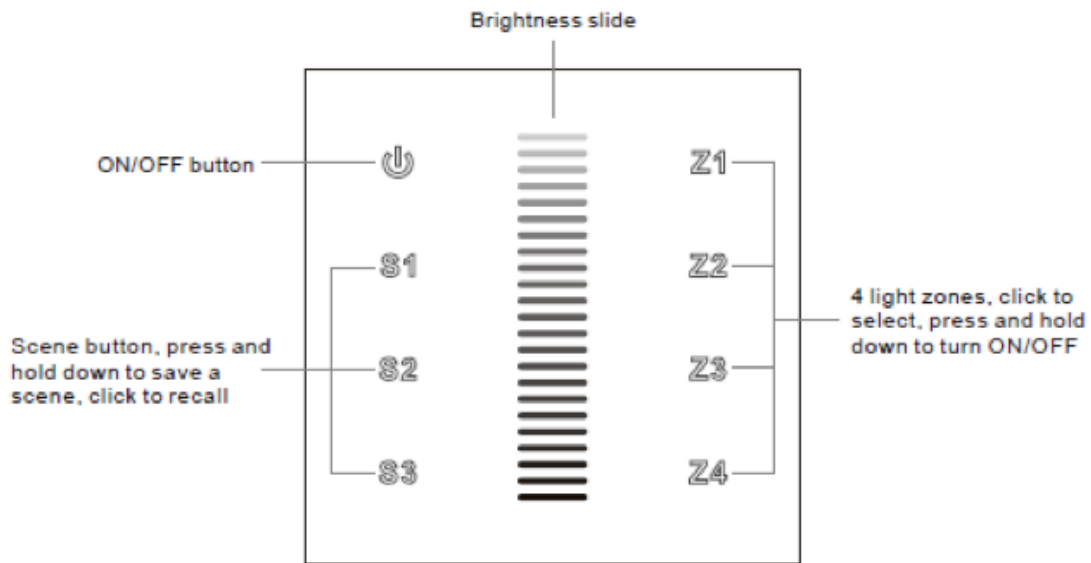

Front side

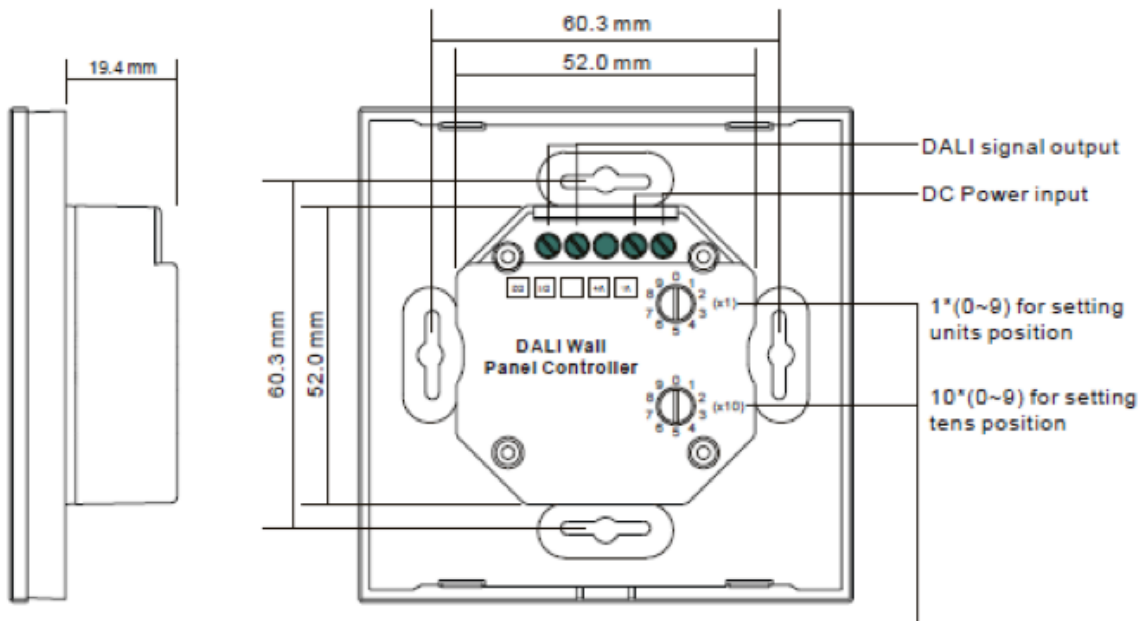

Rotary switches for setting start DALI address number (0-63), the number equals to tens position plus units position

DALI MASTER LC-2300TS RGB

POGODAN ZA UPRAVLJANJE LED TRAKAMA U BOJI

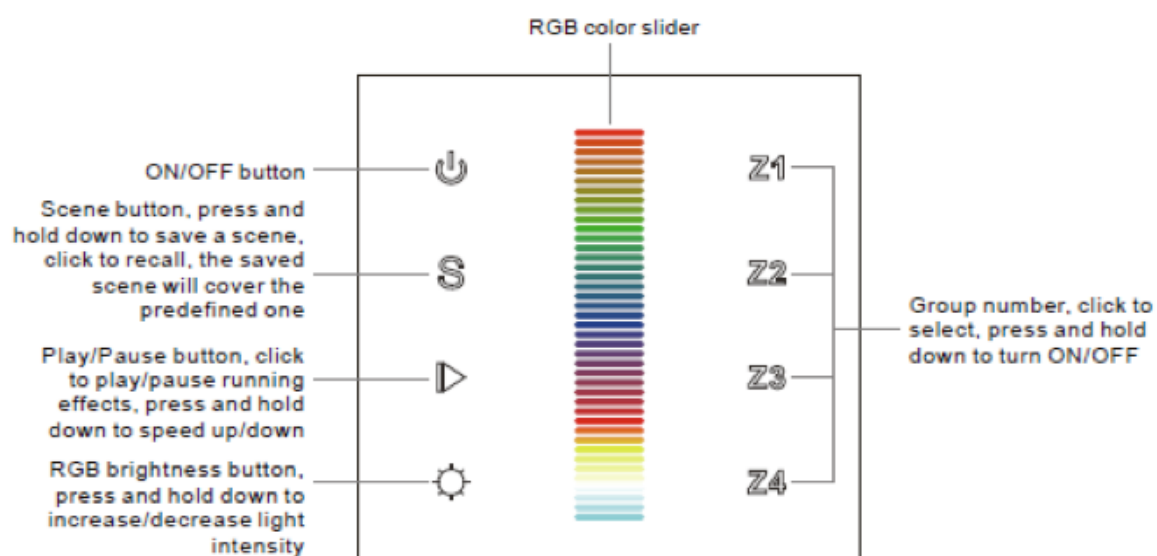

Front side

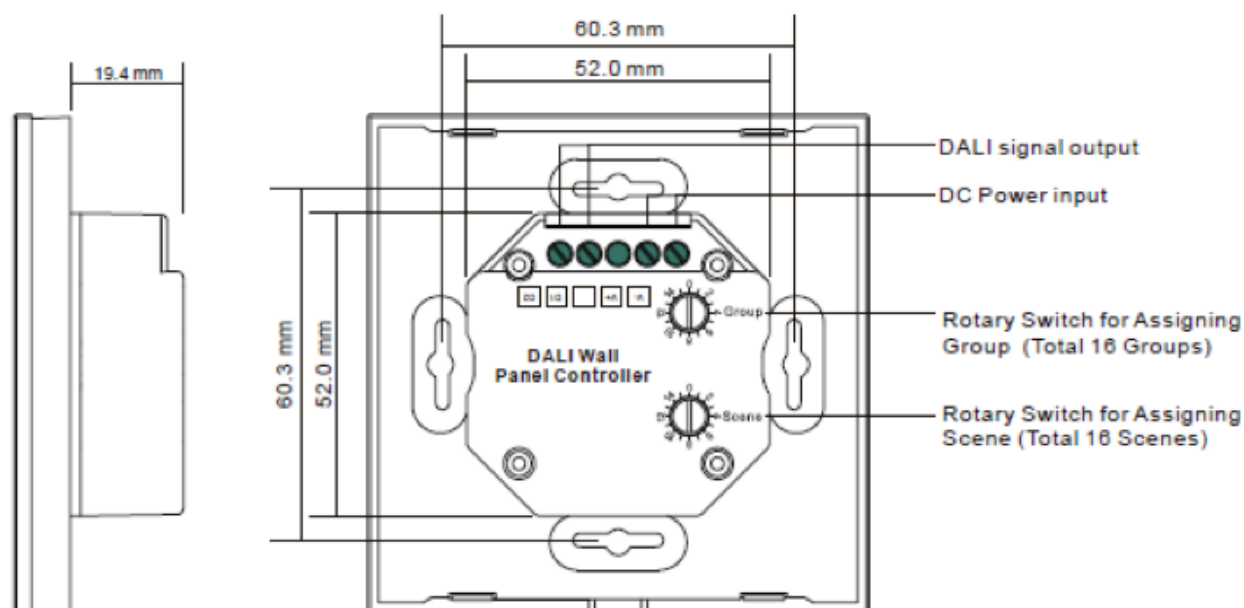

DALI PUSH DIM SWITCH MODULE LC-2400LC

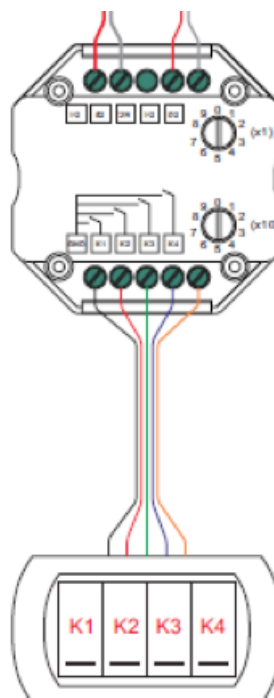
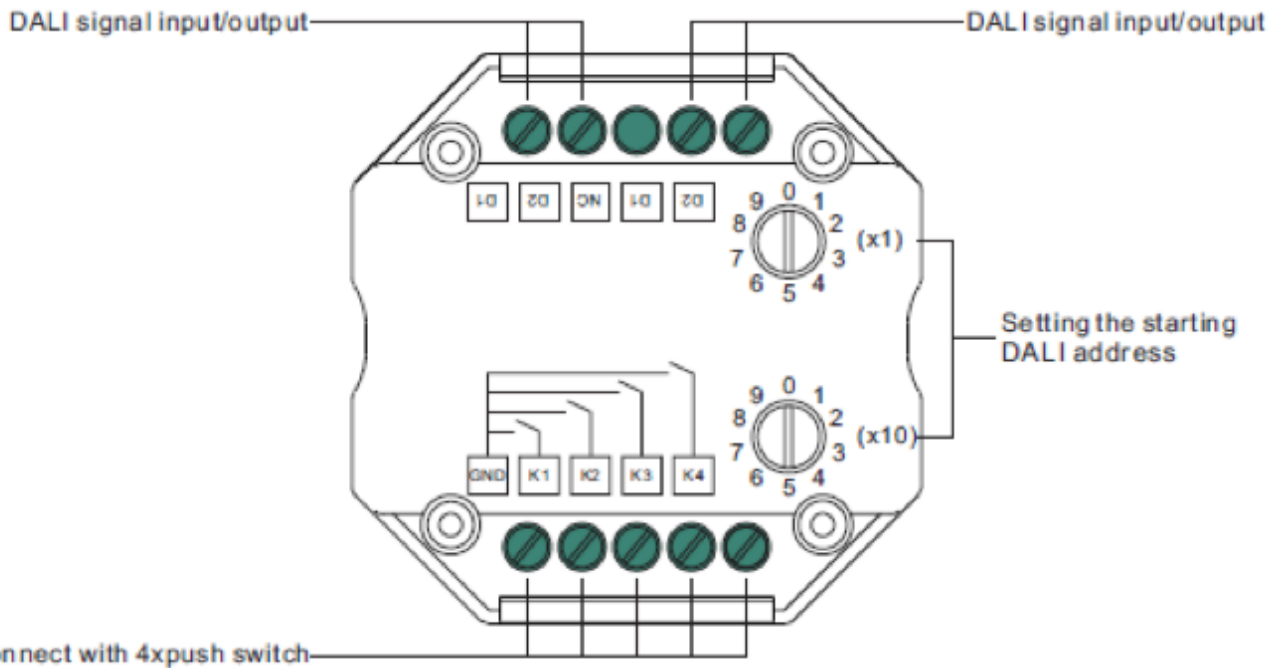

DALI DIMMER (230VAC) LC-2303AC

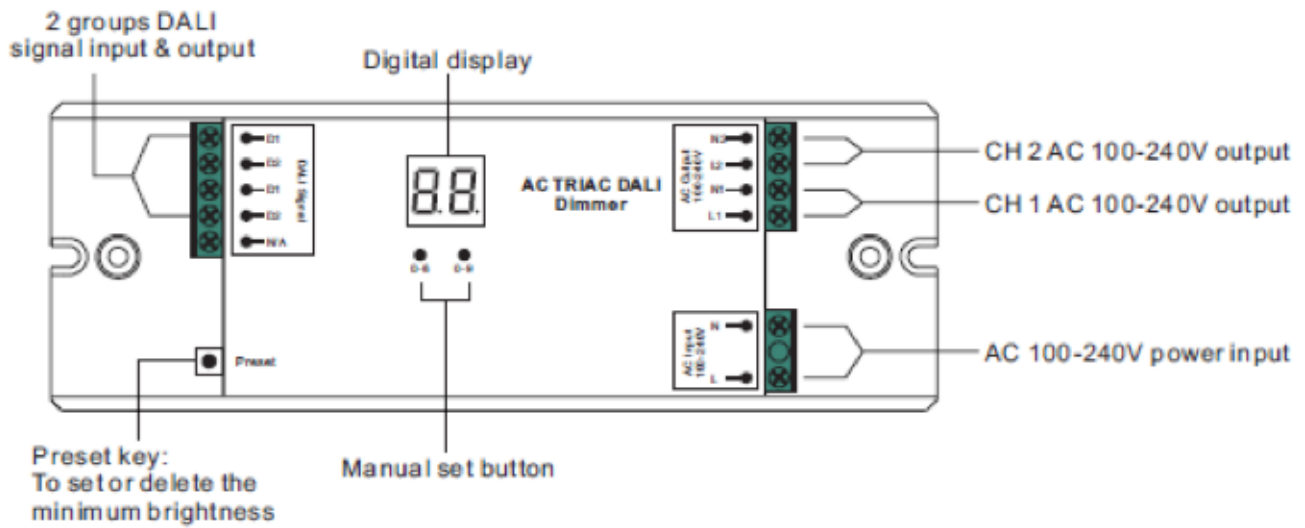

Product Data

Input Voltage	Output Voltage	Output Current	Output Power	Size(LxWxH)
100-240VAC	2x(100-240)VAC	2x1.2A	2x(120-288)W	170x59x29mm

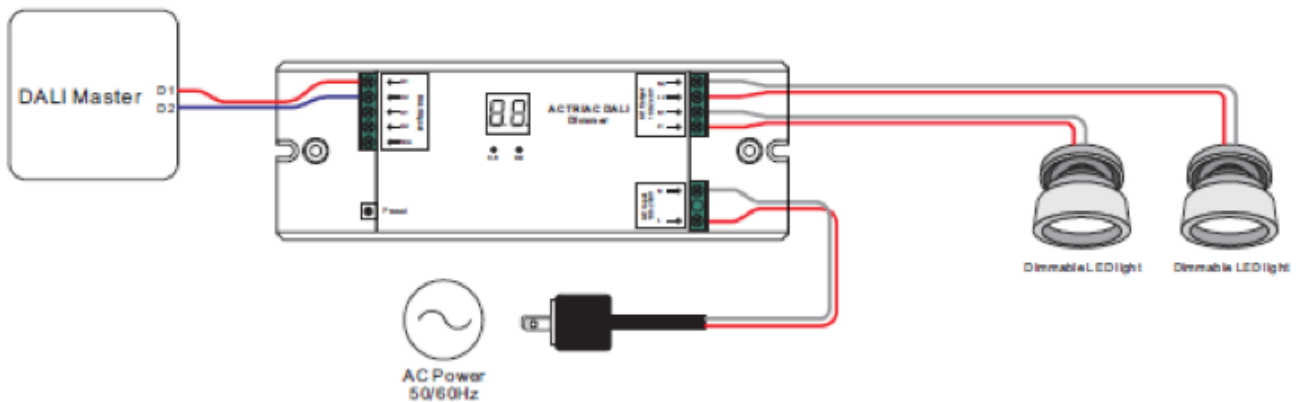

DALI DIMMER (12/24VDC) LC-2302B



1 DALI ADRESA

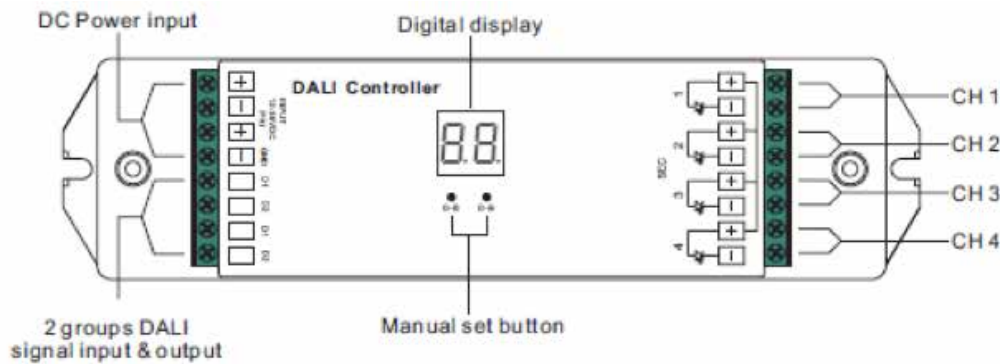

Product Data

No.	Input Voltage	Output Current	Output Power	Remarks	Size(LxWxH)
1	12-36VDC	4x5A	4x(60-180)W	Constant voltage	178x46x22mm

DALI DIMMER (12/24VDC) LC-2303B



4 DALI ADRESE

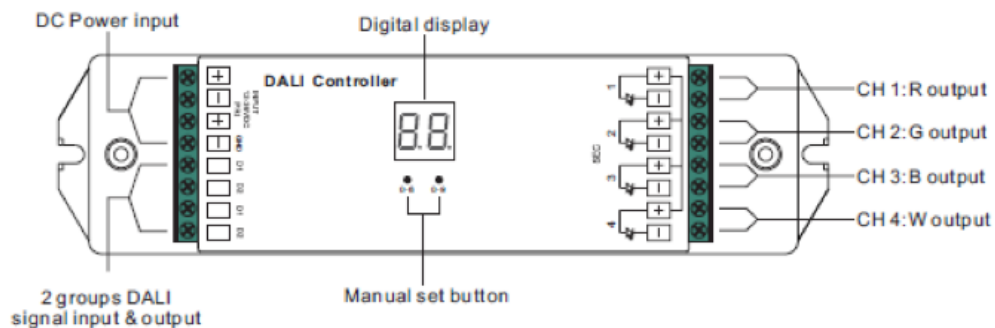

Product Data

No.	Input Voltage	Output Current	Output Power	Remarks	Size(LxWxH)
1	12-36VDC	4x5A	4x(60-180)W	Constant voltage	178x46x22mm

DALI DIMMER (12/24VDC) LC-2304B



PUSH DIM OPTION

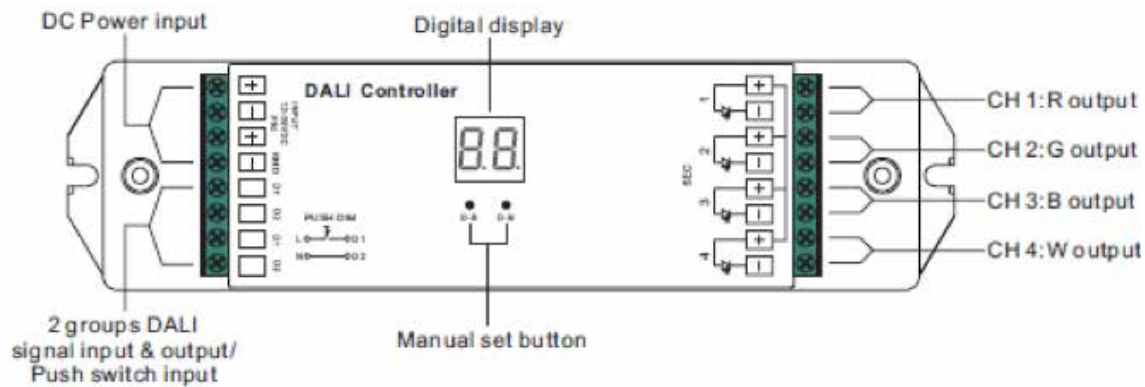

Product Data

No.	Input Voltage	Output Current	Output Power	Remarks	Size(LxWxH)
1	12-36VDC	4x5A	4x(60-180)W	Constant voltage	178x46x22mm

DALI DIMMER (350mA) LC-2316B

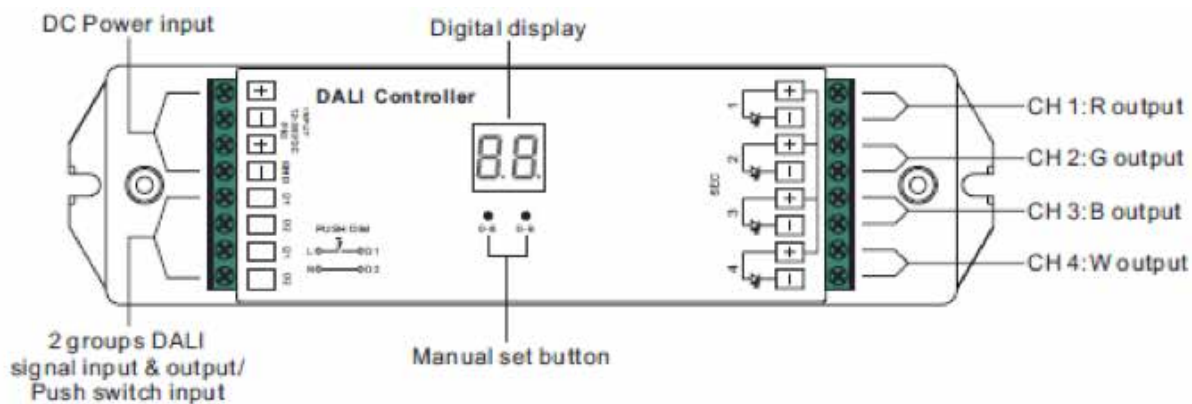

Product Data

No.	Input Voltage	Output Current	Output Power	Remarks	Size(LxWxH)
1	12-36VDC	4x350mA	4x(4.2-12.6)W	Constant current	178x46x22mm

DALI BUS POWER SUPPLY

DLP-04R



DLP-04L



Description

The DALI Power Supply DLP-04 is a power supply with high efficiency and a small size, supplying 240mA for DALI control gears and DALI devices which without power supply circuits. The -20~+60°C wide temperature operating range can meet all kinds of applications.

It is perfectly suitable for power up any products labeled with the DALI trademark. With over 35 years of industrial power supply experience, DLP-04 is engineered to be a reliable and safe solution for DALI bus environment.

SPECIFICATION

MODEL		DLP-04R	DLP-04L	
OUTPUT	RATED DC VOLTAGE	16V		
	DC VOLTAGE RANGE	15.3~18.7V		
	RATED CURRENT	240mA		
	GUARANTEED SUPPLY CURRENT	240mA		
	MAXIMUM SUPPLY CURRENT	250mA		
	RATED POWER	3.84W		
	RIPPLE & NOISE (max.) ^{Note.2}	50mVp-p		
	SETUP, RISE TIME	250ms, 50ms/115VAC, 230VAC		
	HOLD UP TIME (Typ.)	70ms/230VAC	16ms/115VAC at full load	
INPUT	VOLTAGE RANGE	90 ~ 264VAC	120 ~ 370VDC	
	FREQUENCY RANGE	47 ~ 63Hz		
	AC CURRENT (Typ.)	0.1A/115VAC	0.06A/230VAC; Model label: 0.4A/100-240VAC	
	INRUSH CURRENT (Typ.)	COLD START 20A/230VAC		
	LEAKAGE CURRENT	0.5mA / 240VAC		
	NO LOAD POWER CONSUMPTION	Typ. 0.5W		<0.5W

REPEATERS/AMPLIFIERS

MODEL: LC-3001. LC-3002

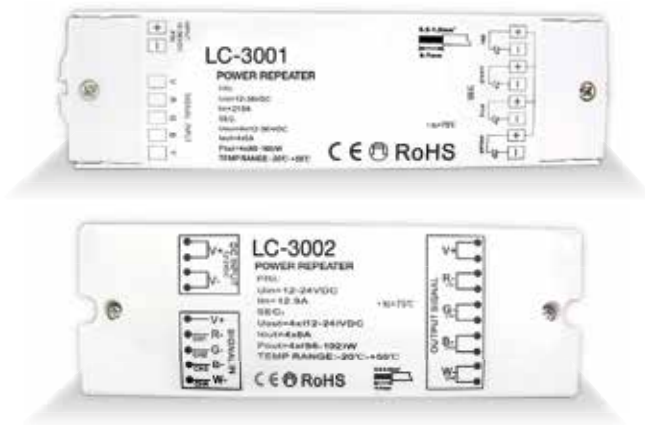

SENSOR SWITCH

MODEL: LC-8001A- FOR HAND WAVE, LC-8001B - FOR CABINET

230VAC ON/OFF



SENSOR SWITCH

MODEL: LC-8001B- SH, LC-8001A-SH 12/24VDC WITH: LC 2901



LC-SH-DRIVER

MODEL: LC-2901 FOR: 8001B-SH, 8001 A-SH



LED DRIVER

MODEL: LC-4113



ECP-1030J/ECP-103AJ

60 -CHANNEL LED WALL CONTROL PANEL



PIR MOTION SENSOR SWITCH LC-8004

LC-8004	370X950X200mm	100-240VAC, 5A, 500W, DETECT HUMAN MOVEMENT TO TURN ON/OFF
LC-8004-DC	370X950X200mm	12-36VDC, 1x8A, 1x(96-288)W, DETECT HUMAN MOVEMENT TO TURN ON/OFF



LED TOUCH SENSOR DIMMER LC-2004

LC-2004	370X950X200mm	12-36VDC, 1x8A, 1x(96-288)W, CONSTANT VOLTAGE, DIM & SWITCH
LC-2004B	370X950X200mm	12-36VDC, 1x8A, 1x(96-288)W, CONSTANT VOLTAGE, ONLY SWITCH



PCBA MINI DIMMER



MODEL: LC-2901S



PLAY RGB RECEPTOR

MODEL: KC-DC-032 (PLAY III & IV) 145x20x18mm DC 10-32V, GENERAL RECEPTOR FOR PLAY RGB CONTROLLER



LED CONTROLLER PLAY III

MODEL: KS-RGB-03

DC 10-32V, GENERAL RECEPTOR FOR PLAY RGB CONTROLLER

How to learn in the receptor



- Press **ON/OFF** key of remote, LED will be ON.
- Touch the receptor learn key, LED will flash.
- Touch color wheel, setting is finished.

How to set static color

- Touch color wheel, color will follow your finger.
- Press **-** **+** to adjust light intensity.
- Press **●** **●** to get white color.

How to set dynamic color

- Press **P** key.
- Touch color wheel, color will follow your finger
- Press **P** key.

How to run dynamic color

- Press **M** to run dynamic.
- Press **◀▶** to change dynamic's speed.



Function

- Wave tide effect.
- DIY white color.
- DIY program.

LC-2839 RGB SET

SR-2839	48x120x17.6mm	4.5VDC, 434MHz/868MHz
SR-1029	46X145X16mm	12-24VDC, 3CH, 5A/CH, 180-360W, CONSTANT VOLTAGE



FUT WIRELESS TOUCH RGB REMOTE CONTROL DC 12

- 8 grades brightness adjusting, to achieve real energy-saving
- Use RF signal for telecontroller, free and easy operation, no direction in 20 meters
- Wide options of over 640 000 colors, adjust to your needs
- Long life, lifespan up to 40 000 hours
- Low energy consumption
- With auto & manual color change mode
- No UV radiation, no stroboflash
- Accord with European Union

Specifications:

- Working voltage: 12-24VDC
- Max load power: 3x6A
- Working frequency: 433MHz (20m)
- Dimension: 114x56x22mm/150g
- Battery: 3xAAA 1.5V

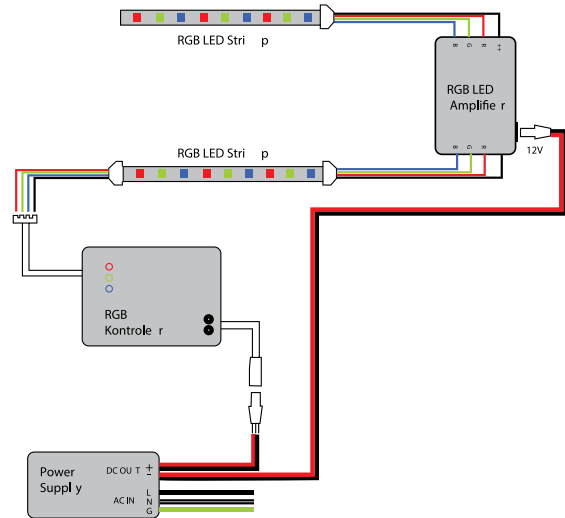

WDC65 LED E27 RGBW SET

3 x RGB žarulje 7W + WLAN kontroler + smartphone aplikacija "LEAD dynamic"



LED NEON C-FR-F21A-24V RGB

13x11.5x29mm

DC24V, 12W/m

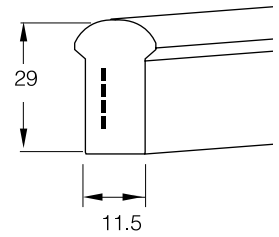
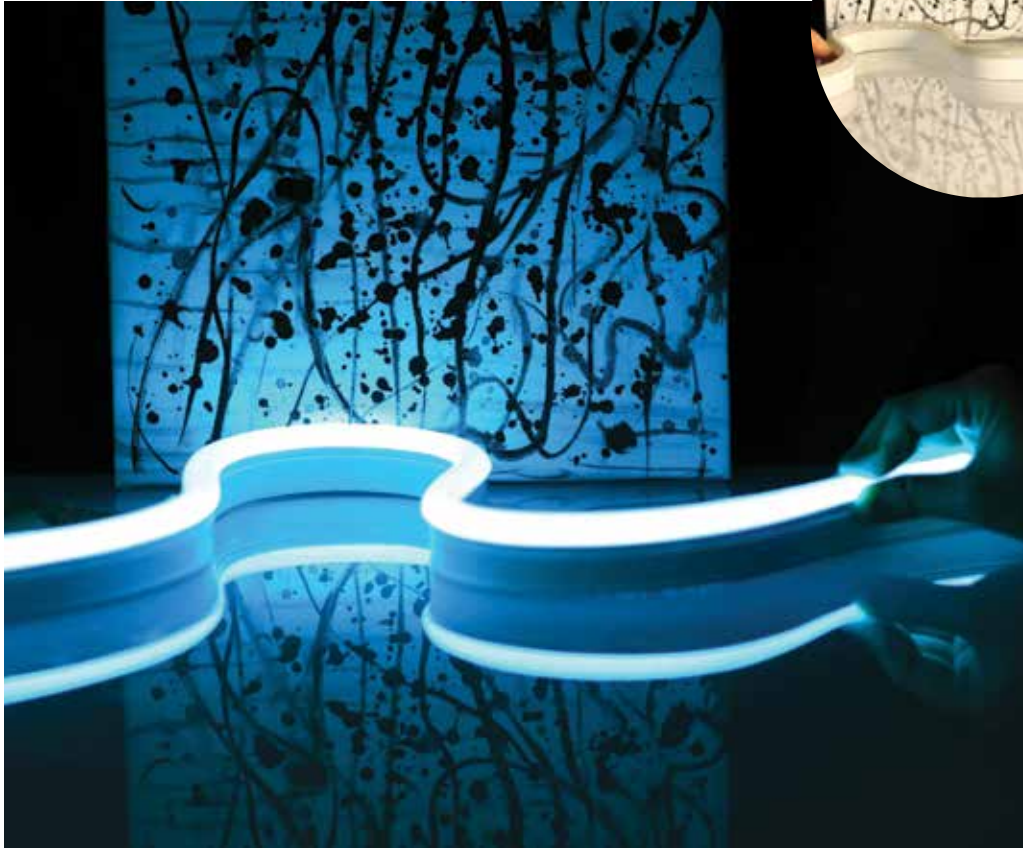
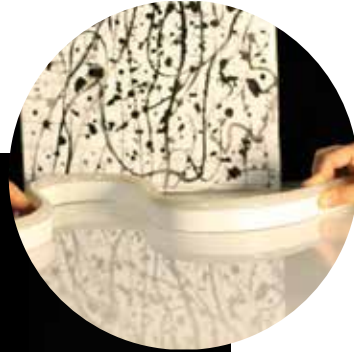

Product Details: Technical Specifications

- Superior Dome Shape
270 Wide Viewing Angle
- Adopts High-brightness
SMD5050 LED as its light
source
- Adopts first-class eco-
friendly UV-resistant PVC
materials

Product Details: Technical Specifications

Model	LED Type	Material	Working Voltage	Rated Power / mtr	LED Qty/mtr	LED Distance	Min. Cutting unit	Min. Cutting length	Max. Connection	IP Rating
C-FR-F21A	SMD 5050	PVC-Ivory White	DC24V	12W	60LEDs	1.67cm	6LEDs	10cm	20mtr	IP68



■ Za neonske znakove

■ Za osvetljavanje stepenica



Završetak kit RGB C-F21A-IP68EC

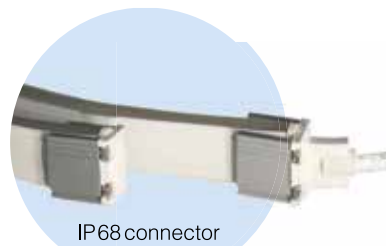

IP68connector

- IP68 END CAP KIT
- IP68 FRONT CONNECTOR KIT

Konektor front kit RGB C-F21A-IP68FC-02



Seamless middle connector

Connects two pieces of lights together seamlessly. IP40 DIY connector

- Silicone gasket *1
- Joint PCB*1
- U steel plate *2
- Anti-skidding clip*2

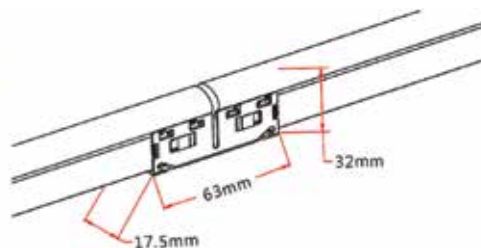

ALU profil U 1m LED neon C-F15/21-ACHM1M

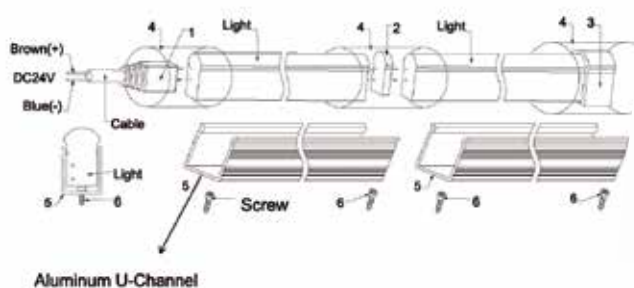

NMS1217

NMS1217-2700K	10.6W/m, 2700K, 24V, IP67
NMS1217-RGB	8.8W, RGB, 24V, IP67
AS-NMS1217MX0-FL	SOLDERING-FREE INTERCONNECTION ACCESSORIES
NMS1217	2x0.5mm ² SOLDERING FREE WATERPROOF CONNECTOR
NMS1217	SILICONE WATERPROOF END CAP
NMS1217A-25 CLIPS	ALUMINIUM CLIPS + SCREWS
NMS1217A-1m PROFILE	ALUMINIUM PROFILE 1m

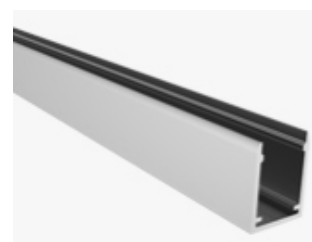
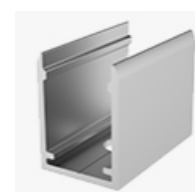

LED-Z22W

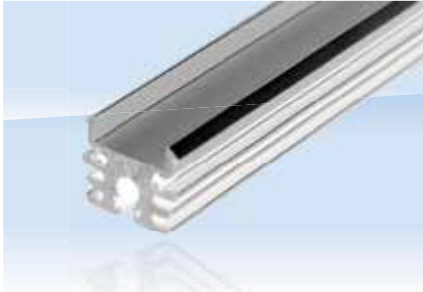

ALU PROFIL

LED-Z22W Aluminijski profil

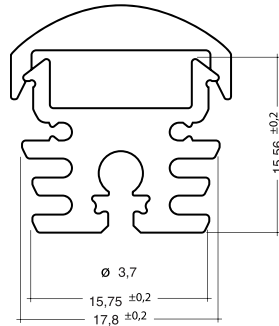

ZAVRŠETAK ZA PROFIL

LED-Z22W
LED-Z22W s ulazom za vodič



NOSAČ PROFILA

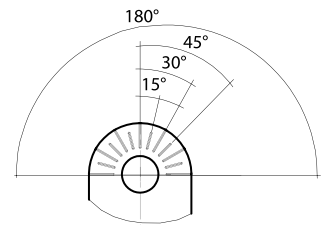
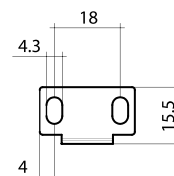
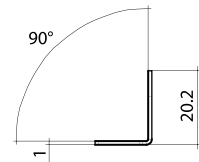
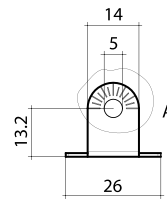
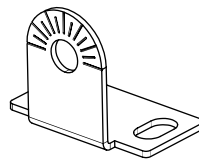

PLOČICA ZA PRIČVRŠČIVANJE

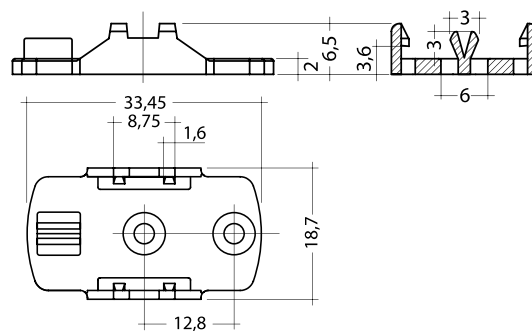

LED-Z220

POKROV ZA ALUMINIJSKI PROFIL

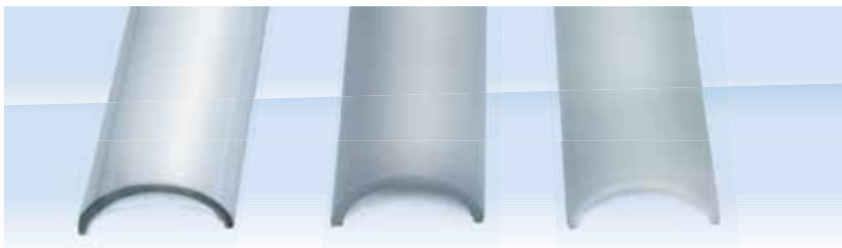
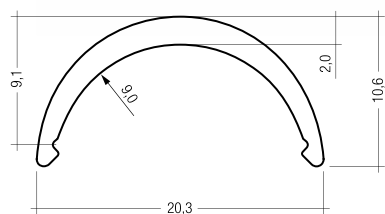

PROZIRNI 2m

MATIRANI 2m

BIJELI 2m

LED-0200

POKROV ZA ALUMINIJSKI PROFIL

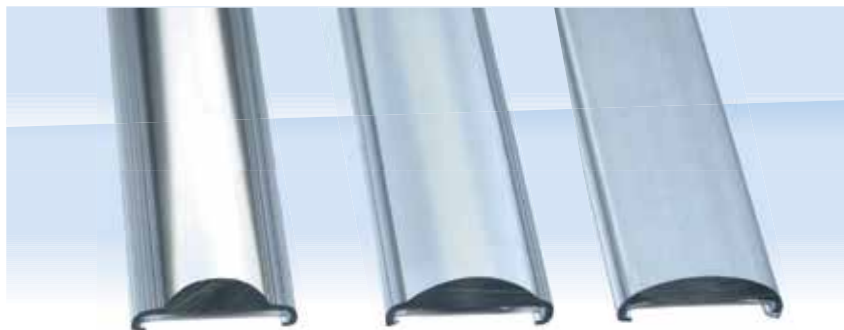

PROFIL LEĆA 30° 2m

PROFIL LEĆA 60° 2m

PROFIL LEĆA 90° 2m

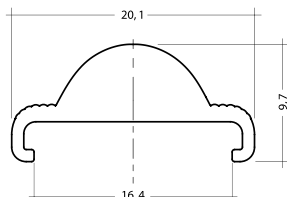

Diagra mLight distribution curve 30°

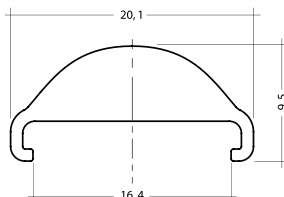
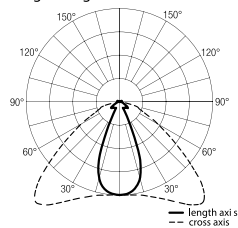

Diagra mLight distribution curve 60°

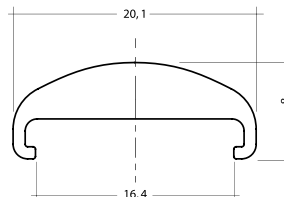
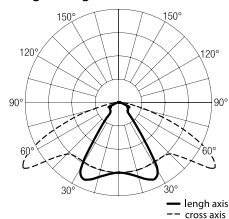

Diagra mLight distribution curve 90°

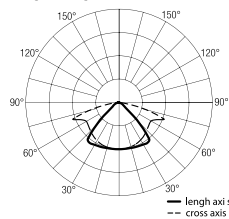

ALP001

ALUMINIJSKI PROFIL UGRADBENI

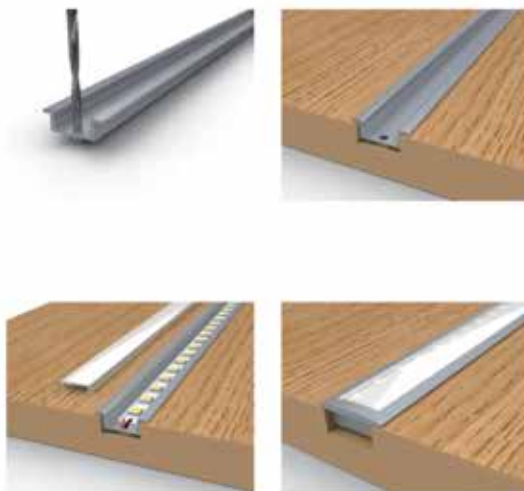
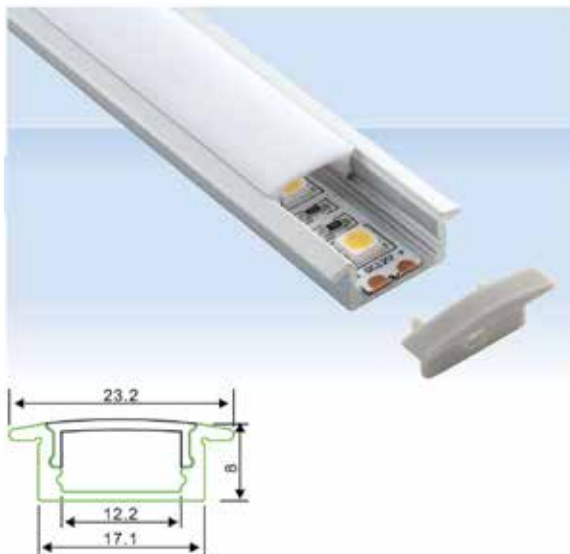

PVC ZAVRŠETAK

ALP001 bez rupe
ALP001 sa rupom



ALU PROFIL

LL-ALP001 Aluminijski profil
7mm ugradbeni 2m



POKROV

CLEAR 2m / SEMI CLEAR 2m /
OPAL MAT 2m



ALP002

ALUMINIJSKI PROFIL NADGRADBENI

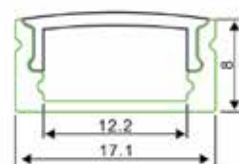

PVC ZAVRŠETAK

ALP002 bez rupe
ALP002 sa rupom

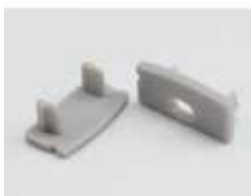

ALU PROFIL

LL-ALP002 Aluminijski profil
7mm ugradbeni 2m



POKROV

CLEAR 2m / SEMI CLEAR 2m /
OPAL MAT 2m



PLOČICA ZA PRIČVRŠČIVANJE

ALP002



ALP003

ALUMINIJSKI PROFIL UGRADBENI

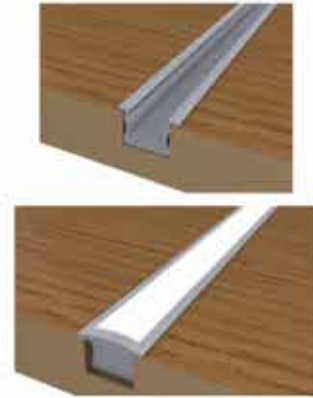

PVC ZAVRŠETAK

ALP003 bez rupe
ALP003 sa rupom



ALU PROFIL

LL-ALP003 Aluminijski profil
15mm ugradbeni 2m



POKROV

CLEAR 2m / SEMI CLEAR 2m /
OPAL MAT 2m



ALP021

ALUMINIJSKI PROFIL NADGRADBENI



PVC ZAVRŠETAK

ALP021 bez rupe
ALP021 sa rupom



ALU PROFIL

LL-ALP021 Aluminijski profil
8.2mm nadgradbeni 2m



POKROV

CLEAR 2m / SEMI CLEAR 2m /
OPAL MAT 2m



ALP023

ALUMINIJSKI PROFIL UGRADBENI

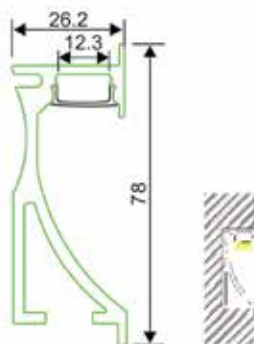

PVC ZAVRŠETAK

ALP023 bez rupe
ALP023 sa rupom



ALU PROFIL

LL-ALP023 Aluminijski profil
ugradbeni zidni 2m



POKROV

CLEAR 2m / SEMI CLEAR 2m /
OPAL MAT 2m

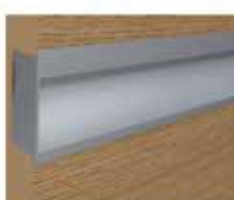
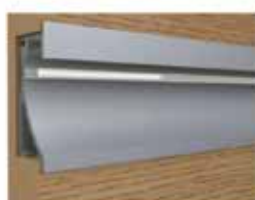

ALP-00X PMMA

POKROV ZA ALUMINIJSKI PROFIL



ALP-00X PMMA
CLEAR 2m



ALP-00X PMMA
OPAL MAT 2m



ALP-00X PMMA
SEMI CLEAR 2m

LL-ALP039

ALUMINIJSKI PROFIL KUTNI

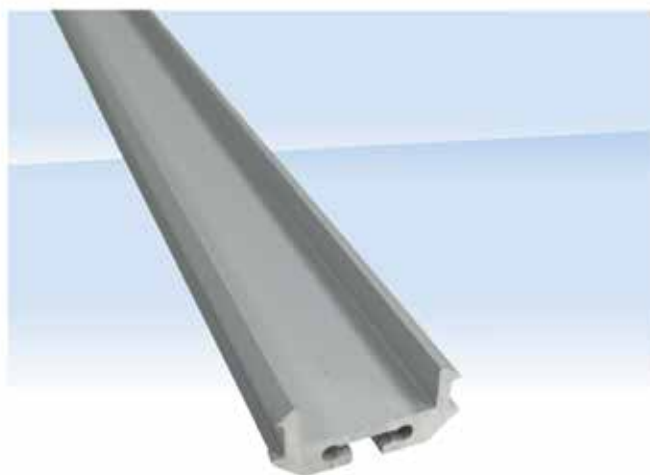

PVC ZAVRŠETAK

ALP039 bez rupe
ALP039 sa rupom



METALNI DRŽAČ PROFILA

ALP039



ALP-039 - 30°
CLEAR 2M/PC



ALP-039 - 60°
CLEAR 2M/PC



ALP-039 - COVER
PMMA CLEAR 2M/PC



ALP-039 - COVER
PMMA SEMMI CLEAR
2M/PC



ALP-039 - COVER
PMMA OPAL MATT
2M/PC



LL-ALP028

NADGRADBENA VISILICA

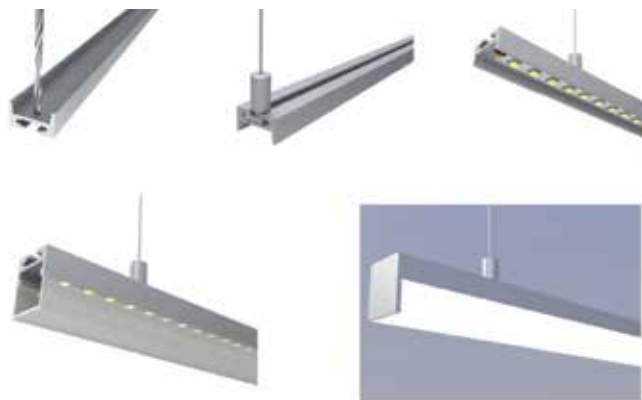
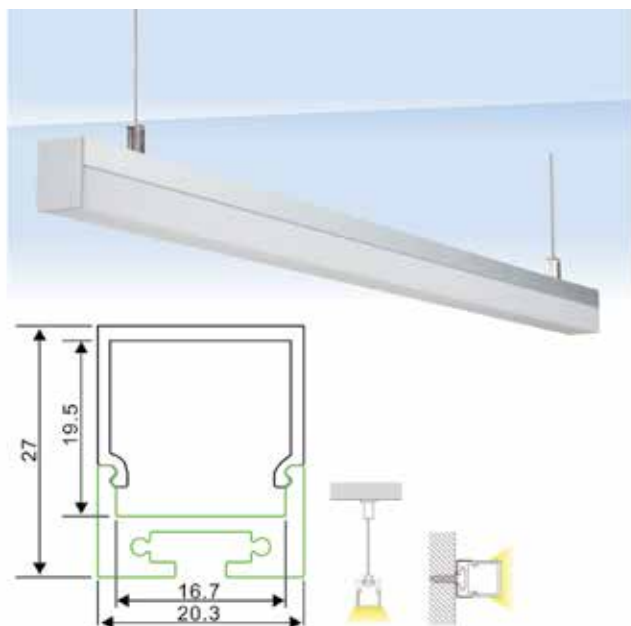

ALU PROFIL

LL-ALP028
Nadgradbena visilica 2m



OVJESNI MEHANIZAM ZA VISILICU

Za profil ALP028



PVC ZAVRŠETAK

ALP028 bez rupe
ALP028 sa rupom



POKROV

ALP028 PMMA
OPAL MAT 2m



LL-ALP007

ALUMINIJSKI PROFIL KUTNI



PVC ZAVRŠETAK

ALP007 bez rupe
ALP007 sa rupom



ALU PROFIL

LL-ALP007 Alumijski
profil kutni 2m



POKROV

ALP00X PMMA
SEMI CLEAR 2m



PVC DRŽAČ PROFILA

ALP007



LL-ALP033

ALUMINIJSKI PROFILU GRADBENI VODOTIJSNI

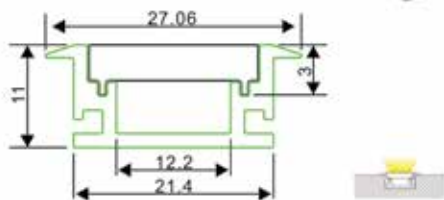

ALU PROFIL

LL-ALP03 Podni ugradbeni vodotijesni 2m



PVC ZAVRŠETAK

ALP033 bez rupe
ALP033 sa rupom



POKROV

ALP033 PC 3mm pojačani 2m



LL-ALP031

ALUMINIJSKI PROFIL UGRADBENI ZIDNI STROPNI

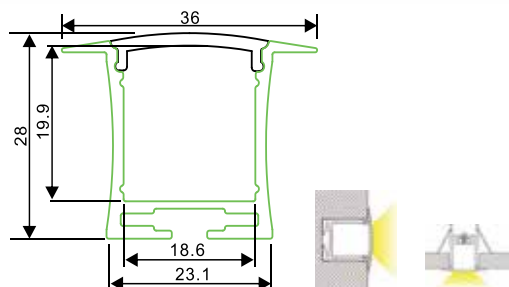
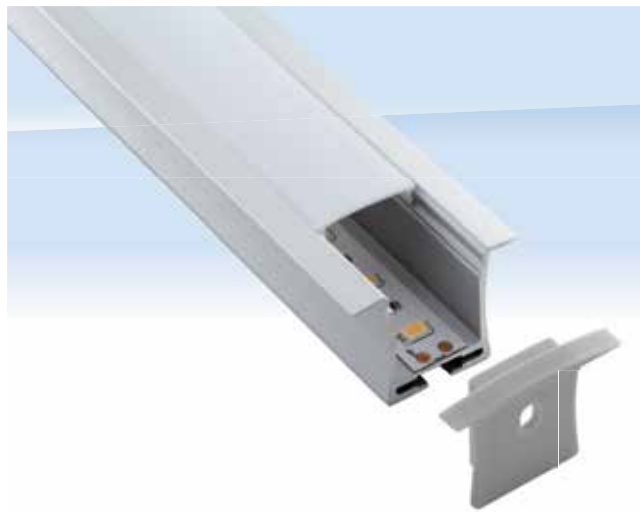

ALU PROFIL

LL-ALP031 UGRADBENI
ZIDNI STROPNI 2m

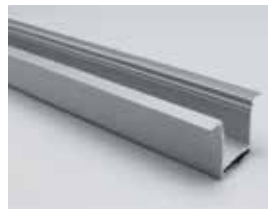

PVC ZAVRŠETAK

ALP031 bez rupe
ALP031 sa rupom



POKROV

ALP031 PMMA
SEMI CLEAR 2m



OPRUGA ZA MONTAŽU PROFILA

ALP031



LL-ALP022

ALUMINIJSKI PROFIL ZA STEPENICE

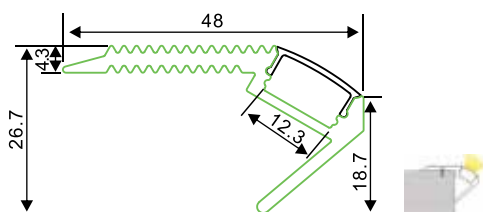

PVC ZAVRŠETAK

ALP022 bez rupe
ALP022 sa rupom



ALU PROFIL

LL-ALP022 Aluminijski profil za
stepenice 2m



POKROV

ALP022 PC
Pojačani 2m



LL-ALP024

ALUMINIJSKI PROFIL ZA STEPENICE

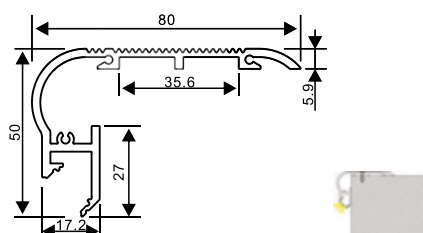

ALU PROFIL

LL-ALP024
ZA STEPENICE 2m



PVC ZAVRŠETAK

ALP024 bez rupe
ALP024 sa rupom



POKROV

ALP00X PMMA
CLEAR / SEMI CLEAR /
OPAL-MATT 2m



LL-ALP054

VIŠEĆI ALUMINIJSKI PROFIL

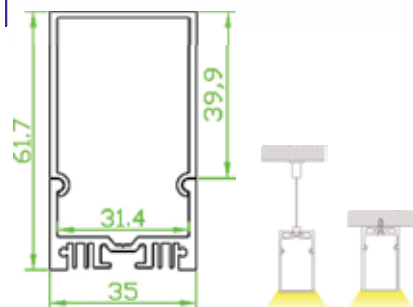

ALU PROFIL

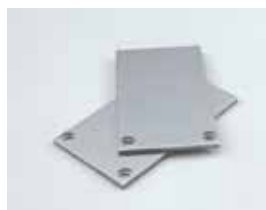

ALU PROFIL

LL-ALP054 Aluminijski profil za vješanje 2m



POKROV

ALP054 PC OPAL-MATT 2m



OVJESNI MEHANIZAM

ALP054 pojačani 2m



LL-ALP050

ALUMINIJSKI PROFIL ZIDNI

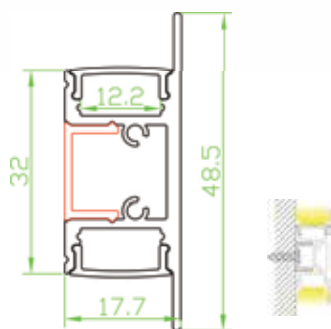
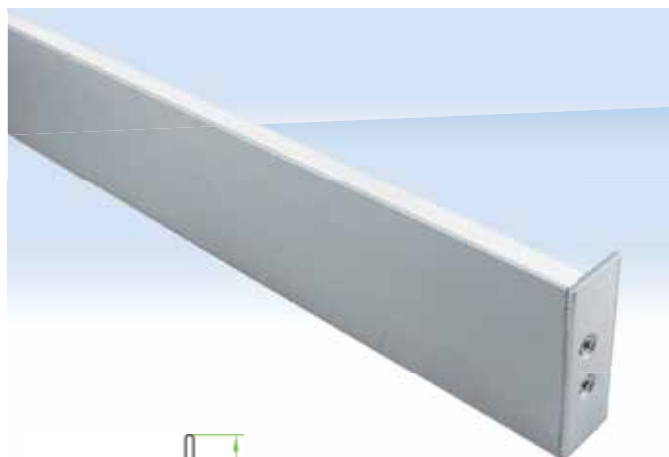

ALU PROFIL

LL-ALP050 ZIDNI 2m



PVC ZAVRŠETAK



POKROV

ALP050 PC SEMI-CLEAR 2m



OPRUGA ZA MONTAŽU PROFILA



LL-ALP045

ALUMINIJSKI PROFIL ZIDNI

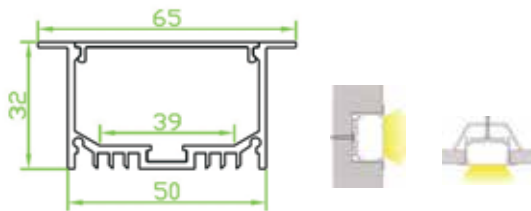

ALU PROFIL

LL-ALP045 ALUMINIJSKI
PROFIL ZIDNI 2m

ZAVRŠETAK



POKROV

ALP045 PC MATT 2m



DRŽAČ PROFILA

ALP045

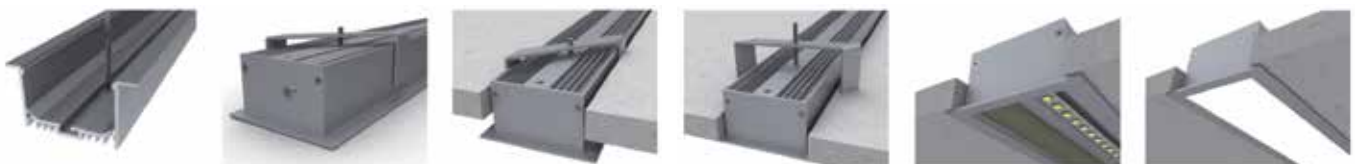

LL-ALP048

ALUMINIJSKI PROFIL VISEĆI

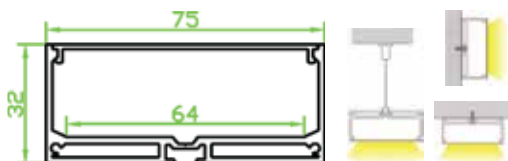
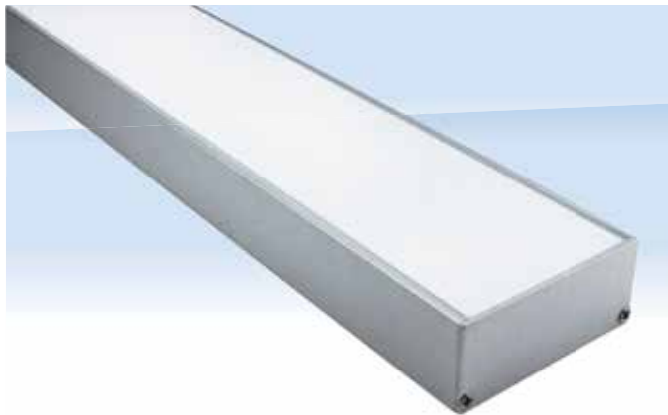

ALU PROFIL

LL-ALP048
Viseći 2m



ZAVRŠETAK



POKROV

ALP048 PC
OPAL MAT 2m



OVJESNI MEHANIZAM ZA VISILICU

ALP048



LL-ALP006

ALUMINIJSKI PROFIL KUTNI



PVC ZAVRŠETAK

ALP006 bez rupe
ALP006 sa rupom



ALU PROFIL

LL-ALP006 Aluminijski profil
kutni 2m



POKROV

ALP006 PMMA
OPAL MAT 2m



DRŽAČ PROFILA

ALP006



ALP 114

FLEKSIBILNI ALUMINIJSKI PROFIL



ALU PROFIL

ALP114 Aluminijski profil
fleksibilni 2m

POKROV

ALP114
OPAL MAT 2m

ZAVRŠETAK



DRŽAČ PROFILA

METALNI

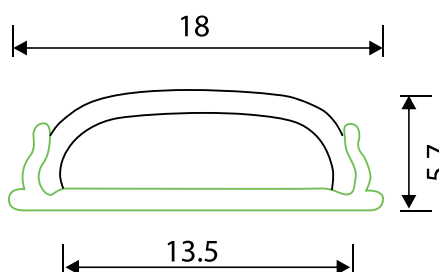

LL-ALP3875-R

Light Source: 2835MD LED module, double rows
Installation: - Surface Mounting Direct
- Suspended Direct
- Wall Mounting

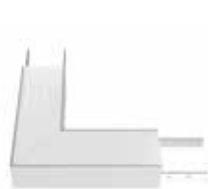
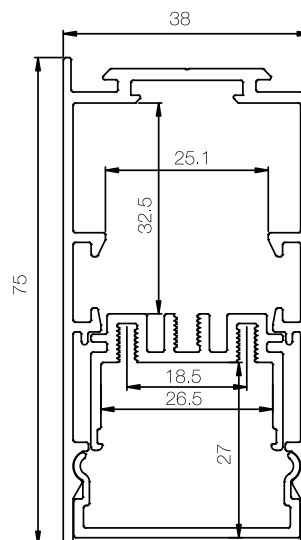
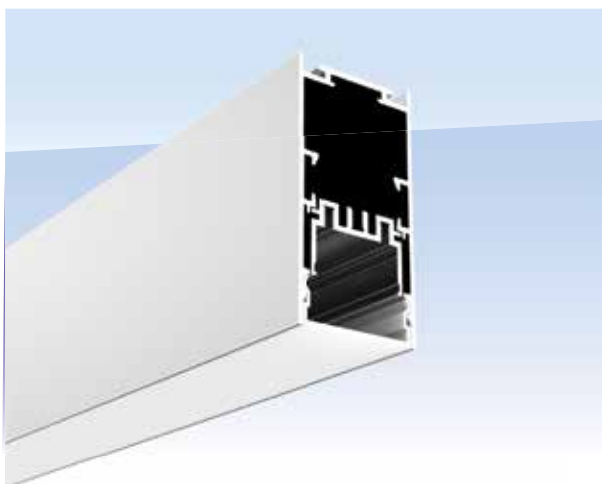
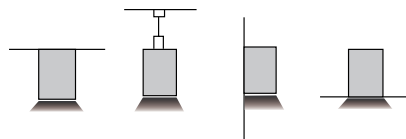

ZAVRŠETAK



DRŽAČ PROFILA UNUTARNJI



DRŽAČ PROFILA VANJSKI



OVJESNI MEHANIZAM ZA VISILICU



MEĐUSPOJNIK PROFILA



ALP 004-R

ALUMINIUM PROFILE, 2M/PC
(STANDARD ALP-00X COVER, THREE TYPES)



PVC ZAVRŠETAK

ALP004-R bez rupe
ALP004-R sa rupom

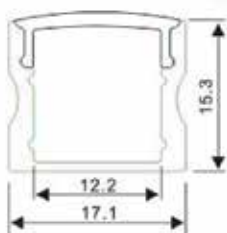

ALP 013

ALUMINIUM PROFILE, 2M/PC

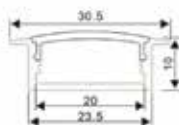
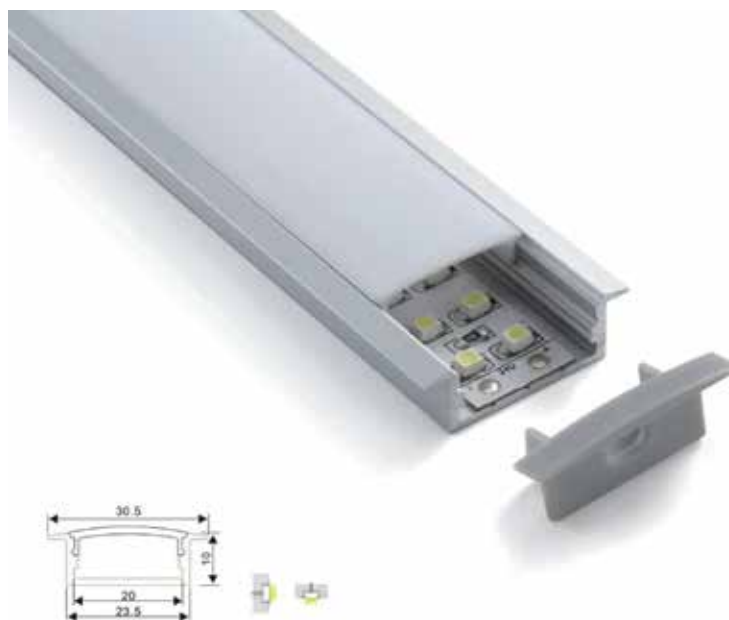

ALUMINIJSKI
PROFIL

POKROV

PVC ZAVRŠETAK

bez rupe
sa rupom



ALP 071

ALUMINIUM PROFILE TRIMLES, 2M/PC

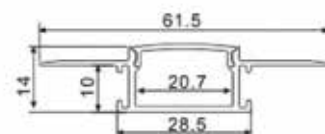

ALUMINIJSKI PROFIL



POKROV
PC opal diffuser cover,
2m/PC



PVC ZAVRŠETAK
bez rupe
sa rupom

ALP 50C

ALP50C STRAIGHT

ALUMINIUM PROFILE WITH PMMA COVER, 2.5M/PC (TO COMPILE WITH A ROUND PROFILE ALP050C INTO DIFFERENT SHAPES) - **PO NARUĐBI, NIJE LAGER**

ALP50C Ø900

ALUMINIUM PROFILE WITH PMMA COVER, FORM A Ø900MM ROUND SHAPE FOR HANGING, LIGHT UP AND DOWN AT THE SAME TIME, BLACK COLOR WITH DIFFUSER/COVER AND ACCESSORIES (IN PARTS, OF 4 PIECES)

ALP50C Ø1270

ALUMINIUM PROFILE WITH PMMA COVER, FORM A Ø1270MM ROUND SHAPE FOR HANGING, LIGHT UP AND DOWN AT THE SAME TIME, BLACK COLOR WITH DIFFUSER/COVER AND ACCESSORIES (IN PARTS, OF 4 PIECES)

ALP50C Ø1800

ALUMINIUM PROFILE WITH PMMA COVER, FORM A Ø1800MM ROUND SHAPE FOR HANGING, LIGHT UP AND DOWN AT THE SAME TIME, BLACK COLOR WITH DIFFUSER/COVER AND ACCESSORIES (IN PARTS, OF 4 PIECES)

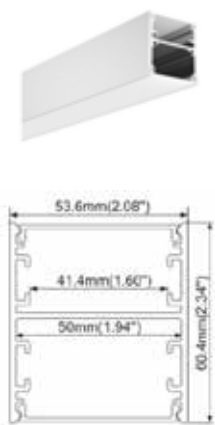

ALP50C STRAIGHT



ALP50C Ø900



ALP50C Ø1270



ALP50C Ø1800



HERMIT CRAB

PANIK LED

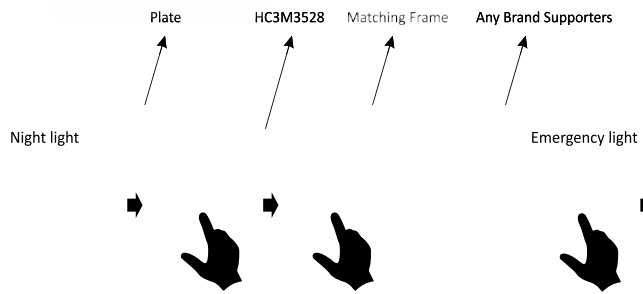

Product Details:
Technical Specifications

Code	Rated voltage	Power	LED	Mode of operation	Duration	Battery	NW(g)
HC3M3528	220-240V~ 50Hz	0.6W	SMD3528	Maintained	3h	Ni-Mh 80mAh 3.6V	52

SMART LED

LED EMERGENCY KIT

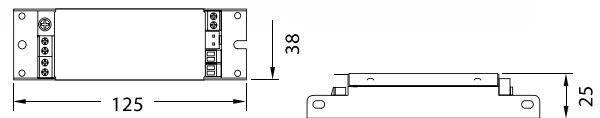
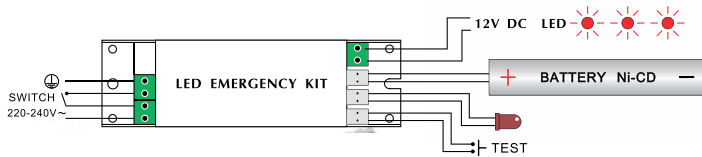

Product Details:
Technical Specifications

Code	Rated voltage	Mode of operation	Duration	Battery	Power	NW(g)
EKL0901	220-240V~	Maintained	1h	Ni-CD 1200mAh 9.6V	Max. 9W	440
EKL0903	220-240V~	Maintained	3h	Ni-CD 3500mAh 9.6V	Max. 9W	1040

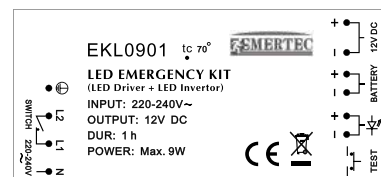

LED DRAWER LIGHT BLS 17

DC6V, 0.8W, 50lm, 4xAAA battery

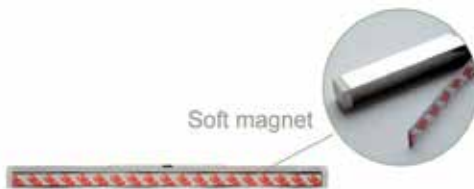

Features

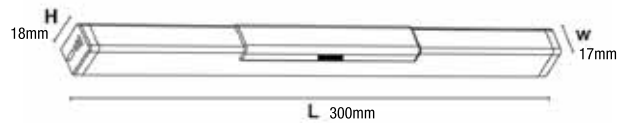
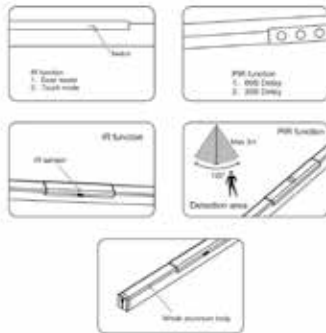

CE RoHS



LED DRAWER LIGHT BLS 47

DC4.2-5V, 0.8W, 50lm, rechargeable batteries included

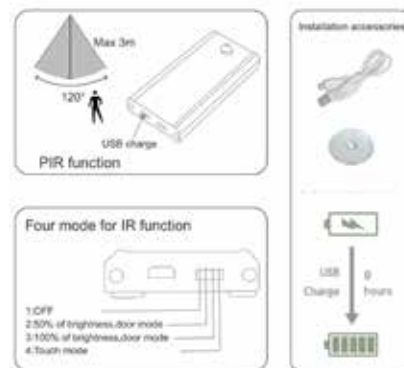
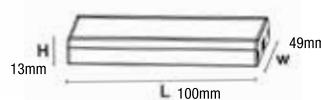

CE RoHS



APOLO LED PANEL

600X600mm



PANEL SURFACE MOUNTING

WHITE FRAME



PANEL PENDANT INSTALLATION

4 LINE/SET



APOLO LED PANEL

300x1200mm



PANEL SURFACE MOUNTING

WHITE FRAME



PANEL PENDANT INSTALLATION

4 LINE/SET



Product Details: Technical Specifications

Products Name	Base	Color	Voltage (V)	LED Qty (pcs)	Total Watts (W)	LED Brand	Beam Angle (°)	CCT (K)	Lumen
28W 600*600 Apollo Panel Light+DALI DIM Driver	Terminal	White	100-240VAC	126	28W	Samsung	85°x 85°	≈ 4000K	3500lm
28W 295*1195 Apollo Panel Light+DALI DIM Driver	Terminal	White	100-240VAC	126	28W	Samsung	85°x 85°	≈ 4000K	3500lm

LED PANEL SLIM 600X600

LED-P1-6060-230V-50Hz-40W-ST-IP20-3000K-3200lm

LED-P1-6060-230V-50Hz-40W-ST-IP20-4000K-3200lm

LED-P1-6060-230V-50Hz-40W-ST-IP20-4000K-5200lm

LED-P1-6060-230V-50Hz-40W-ST-IP20-6500K-3200lm

PANEL PENDANT INSTALLATION

4 LINE/SET



PANEL SURFACE MOUNTING

WHITE FRAME



PANEL PLASTER MOUNTING

4 PCS SPRING/SET



***DIMMABLE WITH YSL 80 DRIVER & PLANA 14135 DIMMER**



LED PANEL SLIM 30X1200

LED-P1-30120-230V-50Hz-40W-ST-IP20-4000K-3200lm

LED-P1-30120-230V-50Hz-40W-ST-IP20-4000K-5200lm

LED-P1-30120-230V-50Hz-40W-ST-IP20-6500K-3200lm

PANEL PENDANT INSTALLATION

4 LINE/SET



PANEL SURFACE MOUNTING

WHITE FRAME



PANEL PLASTER MOUNTING

4 PCS SPRING/SET



***DIMMABLE WITH YSL 80 DRIVER & PLANA 14135 DIMMER**

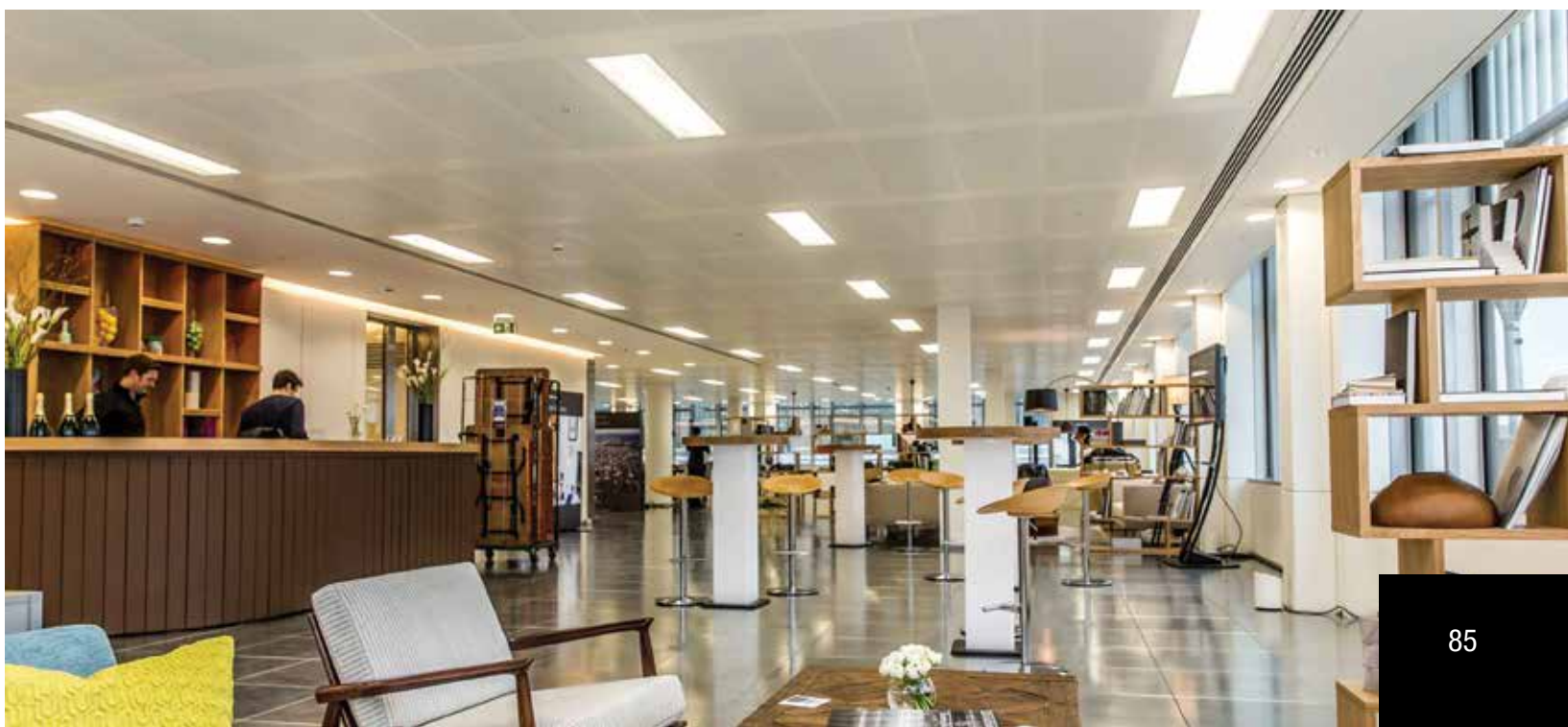

KL-PL-001 -4000K/6500K

LED PROFESSIONAL PANEL



Name	KL-PL-001 39W 4000K	KL-PL-001 39W 6500K
Total Watts	39W	39W
LED Brand	SMD2835	SMD2835
Beam angle (degree)	120°	120°
CCT (K)	≈ 4000K	≈ 6500K
Size (mm)	595*595	595*595
Lumen	4000	4000
CRI	>80	>80
Optional drivers	Non-dim, DALI, 1-10V	Non-dim, DALI, 1-10V
Power Factor	>0.9	>0.9
Lifespan (h)	50,000	50,000

- CRI > 80 and good lighting uniformity
- High visual comfort, UGR < 19
- Provides a wide beam angle of 110°
- Luminaries' efficiency of > 90 lm/W
- Energy saving up to 50% compared with CFL in combination with controls
- Power factor > 0.9
- Integrated Driver, with 1 ~ 10V, DALI dimming controller for choice
- Easy to install with loop-in/out connector
- Exceeds requirements of EN 12464

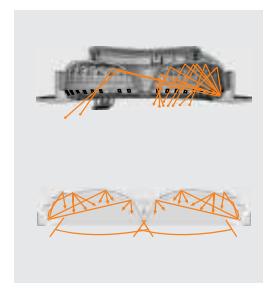
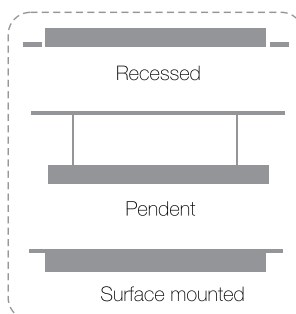
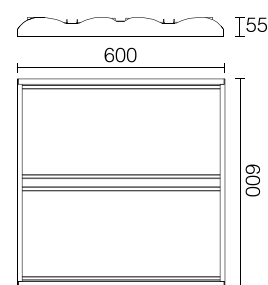

- **Recessed:** Suitable for 15mm to 25mm exposed T-Grid Ceiling
- **Pendant and Surface Mounted:** (requires accessory)
- Quick and easy installation due to its lighter weight
- 5 year manufacturer warranty

- Innovative optical design
- Secondary light distribution wave reflector
- No lens, diffuser or refractor

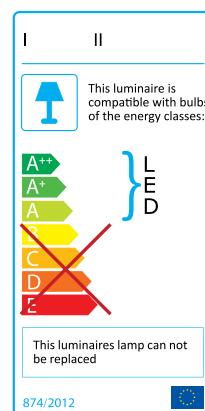

SURFACE OPTION FRAME

600*600mm

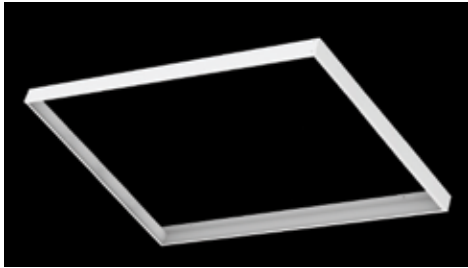

SUSPENSION WIRE

4 line/set



KL-PL-002-6500K

LED PROFESSIONAL PANEL

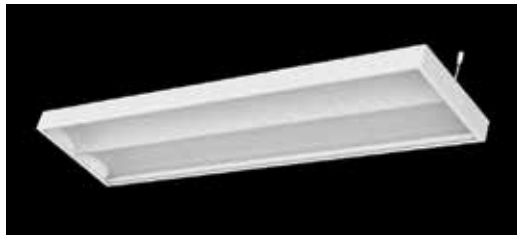

Product Details:
Technical Specifications

Name	KL-PL-002 40W 6500K
Total Watts	40W
LED Brand	SMD2835
Beam angle (degree)	120°
CCT (K)	≈ 6500K
Size (mm)	600*300
Lumen	2800
CRI	>80
Optional drivers	Non-dim, DALI, 1-10V
Power Factor	>0.9
Lifespan (h)	50,000

- CRI > 80 and good lighting uniformity
- High visual comfort, UGR < 19
- Provides a wide beam angle of 110°
- Luminaries' efficiency of > 90 lm/W
- Energy saving up to 50% compared with CFL in combination with controls
- Power factor > 0.9
- Integrated Driver, with 1 ~ 10V, DALI dimming controller for choice
- Easy to install with loop-in/out connector
- Exceeds requirements of EN 12464

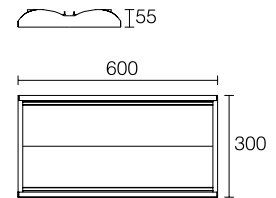

IP44 CRI 82

LED 1-10V LED DALI

860 cd 103 lm/w

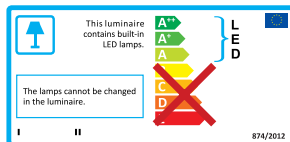

SURFACE OPTION FRAME

300*1200mm



SKYLINE

SKY-06A840B 6M LENGHT, 20MM WIDTH, BLACK, SET

SKY-12C840B 12M LENGHT, 20MM WIDTH, BLACK, SET

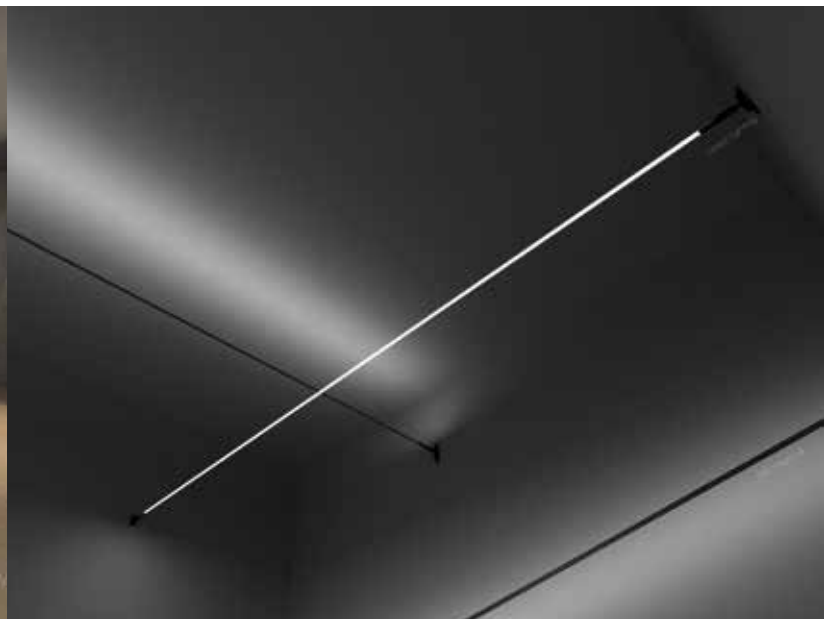

LED TRACK LIGHT KT32210

- Power: 30W
- Optics: Lens
- Driver: Built-in OSRAM driver
- Voltage: AC 220-240V
- CCT: 4000K
- Luminous Flux: 2500lm
- Beam Angle: Without Lens
- CRI: >90
- Material: Die-casting Aluminum
- Light Source: Bridgelux COB
- Adapter: 3-circuit
- Surface Finish: Powder Coating
- Color: Black (new version)
- Warranty: 3 years



15° LENS FOR KT32210



36° LENS FOR KT32210



CEILING BASE FOR TRACK LIGHT

CEILING BASE FOR 4-WIRE 3-PHASE TRACK LIGHT
DIMENSION: Ø100MM, COLOR: BLACK

